



Ultra 4.0
and
Ultra 4.5

OPERATIONS MANUAL

Original Instructions
ATEX Version

602569-05 (doc # 602569-05)
(04/13/2021)



Copyright QED Environmental Systems, 2021

QED Environmental Systems - 2355 Bishop Circle W. Dexter, Michigan 48130-1592
1-800-624-2026 (North America Only) (734) 995-2547 - Tele (734) 995-1170 - Fax info@qedenv.com - E-mail www.qedenv.com

The equipment in this manual is protected under U.S. and foreign patents issued and pending:

U.S. Patents:

AutoPump (AP) 5,004,405

"AP" is a Registered Trademark of "QED Environmental Systems"

"AutoPump" is a Registered Trademark of "QED Environmental Systems"

The QED Environmental Systems logo is a Registered Trademark of "QED Environmental Systems" QED

Environmental Systems is a Registered Trademark of "QED Environmental Systems"

INTRODUCTION.....	1
SAFETY	1
HOW TO CONTACT QED	1
CHAPTER 1: SAFETY	2
A PARTIAL LIST OF SAFETY PROCEDURES	2
FIRE AND EXPLOSION PROTECTION	2
CHAPTER 2 ATEX CERTIFICATIONS, LABEL DETAIL AND EXPLANATION	3
CHAPTER 3: OVERVIEW	5
GENERAL SPECIFICATIONS	5
THIS IS HOW IT WORKS	5
CHAPTER 3: OVERVIEW	6
CHAPTER 4: EQUIPMENT	8
UNPACKING	8
EQUIPMENT LIST	8
SINGLE STAGE FILTER/REGULATOR	8
CHAPTER 5: INSTALLATION	9
HOSE BUNDLES	11
CHAPTER 6: MAINTENANCE	14
CLEANING THE PUMP INTERIOR	14
MINERAL BUILD-UP CLEANING PROCEDURE	14
CHAPTER 7: TROUBLESHOOTING & REPAIRS	22
TROUBLESHOOTING	22
RETURNING EQUIPMENT FOR SERVICE	24
EQUIPMENT CLEANING REQUIREMENTS	24
SPECIFICATIONS	25
BOTTOM INLET, LONG	25
SPECIFICATIONS	33
TOP INLET, LONG	33
SPECIFICATIONS	34
TOP INLET, LONG	34
SPECIFICATIONS	35
TOP INLET, LONG	35
SPECIFICATIONS	36
TOP INLET, LONG	36
SPECIFICATIONS	37
TOP INLET, SHORT	37
SPECIFICATIONS	38
TOP INLET, SHORT	38
SPECIFICATIONS	39
TOP INLET, SHORT	39
SPECIFICATIONS	40
TOP INLET, SHORT	40
SPECIFICATIONS	41
BOTTOM-INLET	41
4.5 ULTRA 180°F MAX	41
SPECIFICATIONS	42
BOTTOM-INLET	42
4.5 ULTRA 250°F MAX	42
SPECIFICATIONS	43
AP ULTRA PUMP - TERMS, CONDITIONS, AND WARRANTY	44
FIGURES:	
FIGURE 1 - ATEX LABEL DETAIL AND EXPLANATION	3
FIGURE 2 ATEX LABEL LOCATION AND APPEARANCE	4
FIGURE 3 - HOW IT WORKS	6
FIGURE 4 - OVERVIEW OF THE AP ULTRA SYSTEM	7
FIGURE 6 - EXAMPLES OF WELL CAPS	12
FIGURE 7 - HOSE BUNDLING	13
FIGURE 8 - EXPLODED VIEW OF BOTTOM-LOADING ULTRA (LONG AND SHORT)	15
FIGURE 9 - EXPLODED VIEW OF TOP-LOADING ULTRA (LONG AND SHORT)	16
FIGURE 13 - EXPLODED VIEW OF AP ULTRA LEVER ASSEMBLY	20
FIGURE 14 - EXPLODED VIEW OF 1 INCH CHECK VALVE	21

Welcome to QED Environmental Systems' AutoPump® (AP4 Ultra 4.0) manual.

To ensure the best operator safety and system performance, it is strongly recommended that the operators read this entire manual before using the system.

This manual reflects our many years of experience and includes comments and suggestions from our sales and service personnel and most importantly from our customers. The chapters, their contents and sequence were designed with you, the user and installer, in mind. We wrote this manual so it can be easily understood by users who may not be familiar with systems of this type or are using a QED system for the first time.

Safety

Safety has been a cornerstone of our design which has been proven out in building and shipping systems throughout the world. Our high level of performance is achieved by using quality components, building in redundancies or backup systems, and not compromising our commitment to quality manufacturing. The net result is the highest quality and safest pneumatic pump recovery system on the market. We feel so strongly about safety, based on years of working with the hydrocarbon industry, that it is the first section of all our manuals

How to Contact QED

If for any reason you are unable to find what you need in this manual feel free to contact the QED Service Department at any time. We encourage you to use the following communication methods to reach us at any time:

Service Department
QED Environmental Systems
www.qedenv.com

2355 Bishop Circle W.
Dexter, Michigan 48130-1592

(800) 624-2026 — North America Only
(734) 995-2547 — Tele.
(734) 995-1170 — Fax
info@qedenv.com — E-mail

QED can be reached 24 hours a day

We welcome your comments and encourage your feedback regarding anything in this manual and the equipment you have on-site.

Thank you again for specifying QED equipment.

Safety has been a prime consideration when designing the AutoPump System. Safety guidelines are provided in this manual, and the AutoPump System safety features are listed below. Please do not attempt to circumvent the safety features of this system.

We have also listed some possible hazards involved when applying this system to site remediation. Nothing will protect you as much as understanding the system, the site at which it is being used, and the careful handling of all equipment and fluids. If you have any questions, please contact the QED Service Department for guidance.

As you read through this manual, you will encounter three kinds of warnings. The following examples indicate how they appear and lists their respective purposes.

Note: Highlights information of interest.

Caution: Highlights ways to avoid damaging equipment.

Warning: Highlights personal safety issues.

A Partial List of Safety Procedures



WARNING: The air compressor and any other electrical equipment used with this pneumatic system must be positioned outside of any area considered hazardous because of possible combustible materials.

These safety procedures should be followed at all times when operating QED equipment on or off site, and should be considered as warnings:



- Wear safety goggles when working with the AutoPump System to protect eyes from any splashing or pressure release.
- Wear chemically resistant rubber gloves, boots, and coveralls when handling the AutoPump and fluid discharge hose to avoid skin contact with the fluid being removed
- Point tubing/hoses away from personnel and equipment when connecting or disconnecting.
- Always ensure that the fluid discharge line is connected before the air line to prevent accidental discharge.



The AutoPump System minimizes the potential for accidents with the following safeguards:

Fire and Explosion Protection

Almost all of QED underground fluid extraction systems are pneumatic. This offers many inherent fire and explosion protection features.

Equipment with an **ATEX** label similar to the example in **Figure 1**, is **ATEX** certified. Equipment without the label is not **ATEX** certified.

Figure 1 explains the **ATEX** label, **Figure 2**, (following Page) shows the label location and appearance.

Figure 1 - ATEX Label Detail and Explanation

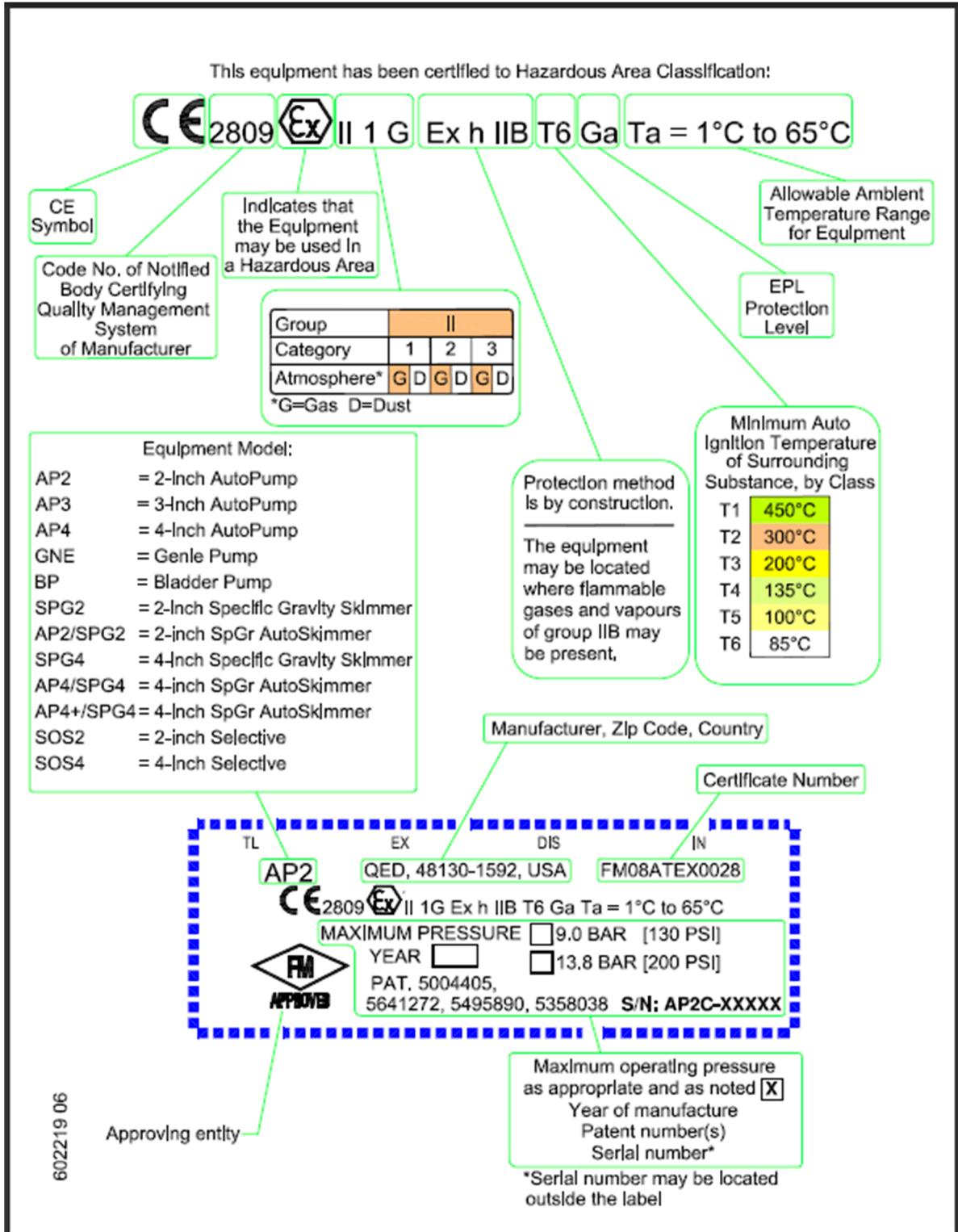



Pump Serial Numbers Located on the Pump's Head

Figure 2

The AutoPump® fills and empties automatically, and is very easy to install, use, and maintain.

The AutoPump is a pneumatic fluid extraction pump that pumps in pulses. It handles any liquid which flows freely into the pump and is compatible with the component materials and with the connecting hoses. The AP Ultra is intended for vertical operation in well casings with a 3.75-inch(9.53cm) or greater internal diameter. It can pump particles up to 1/8-inch in diameter.

The AutoPump is very versatile and available in a wide range of lengths, valve arrangements, and materials of construction to meet particular site specifications.

Equipment will vary by application and site specifications. (See Chapter 3)

General Specifications

Pump Diameter:	3.6 inch (91 mm)
Pressure Range: High	5 - 120 psi (0.4 - 8.5 Kg/cm ²)
Pressure Option: Flow	5 - 200 psi (0.4 - 14.1 Kg/cm ²)
Ranges:	0-14 gallons per minute (0-53 liters per minute)

This is How it Works

The AutoPump is a submersible compressed air-driven pump which fills and empties automatically. It also controls the fluid level in a well automatically. The pump fills (See **Figure 3**) when fluids enter either the top or bottom check valve. Air in the pump chamber exits through the exhaust valve as the fluid fills the pump. The float inside the pump is carried upwards by the fluids rising in the casing until it pushes against a stop on the control rod, forcing the valve mechanism to switch to the discharge mode.

The switching of the valve causes the exhaust valve to close and the air inlet valve to open. This causes the pump to empty (see **Figure 3**) by allowing compressed air to enter the pump. This pressure on the fluid closes the inlet check valve and forces the fluids up the discharge line and out of the pump through the outlet check valve. As the fluid level falls in the pump, the float moves downward until it pushes against the lower stop on the control rod, forcing the valve mechanism to switch to the fill mode. The outlet check valve closes and prevents discharged fluids from re-entering the pump. The filling and discharging of the pump continue automatically.

NOTE: The figures shown here are simplified schematics.

Figure 3 - How it Works

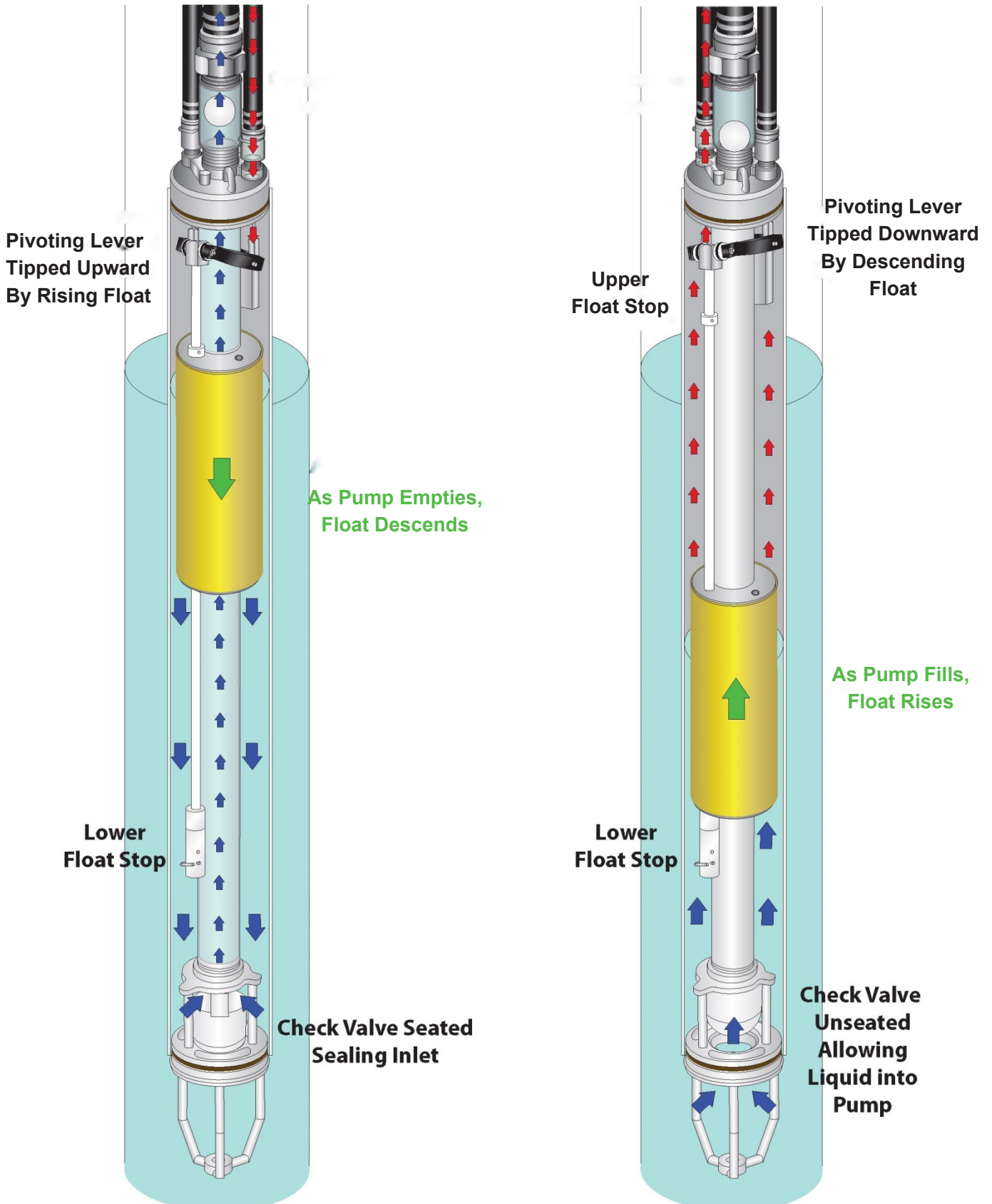
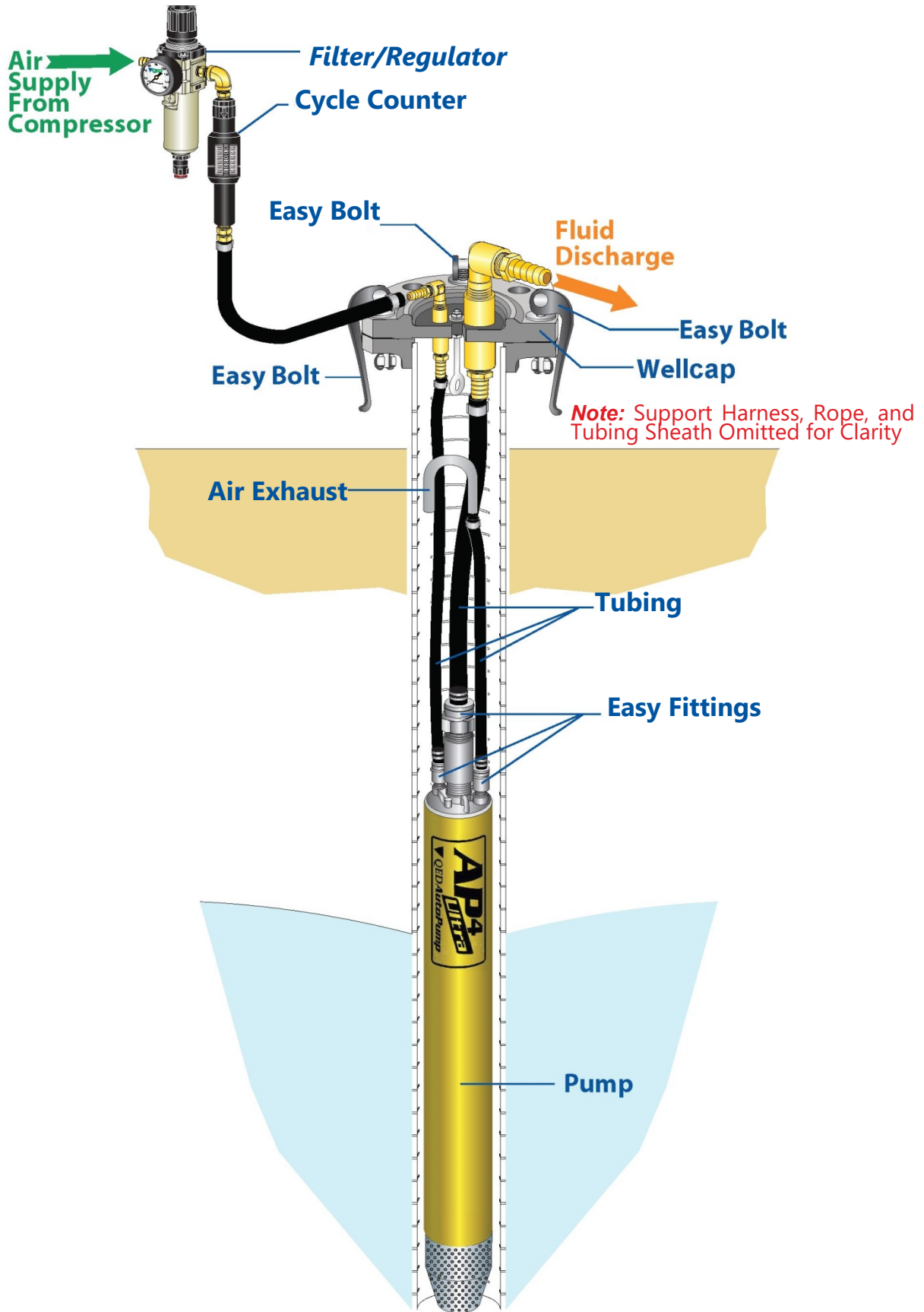

Figure 4 - Overview of the AP Ultra System

AP Ultra System provides everything required for pumping fluid from a well.



Unpacking

During the unpacking procedure, check for the following:

- All parts on the packing list have been included in the box
- All fitting openings are unobstructed
- The equipment has not been damaged in shipment

Equipment List

The equipment list will vary depending on site specifications, but the following list is a typical configuration

1. Top-Loading or Bottom-Loading AP Ultra with support harness
2. Single stage filter/regulator with:
 - 5 Micron filter with auto drain tap
 - Pressure regulator with gauge
 - Maximum operating pressure 120 P.S.I. (8.4 Kg/cm²)
3. Pump Cycle Counter (PCC)
4. Pump support system:
 - Well cap
 - Polypropylene support rope with quick-link assembly or SS wire rope (Alternate materials as required)

Single Stage Filter/Regulator

A single stage 5 Micron particulate air filter/regulator has a manual or an optional automatic drain and is installed on the system air supply line. The filter/regulator removes particles and water droplets from the air passing to the AP Ultra.

NOTE: Too much air pressure can result in low pump efficiency

Figure 5 - Single Stage Filter/Regulator with Quick-Connects

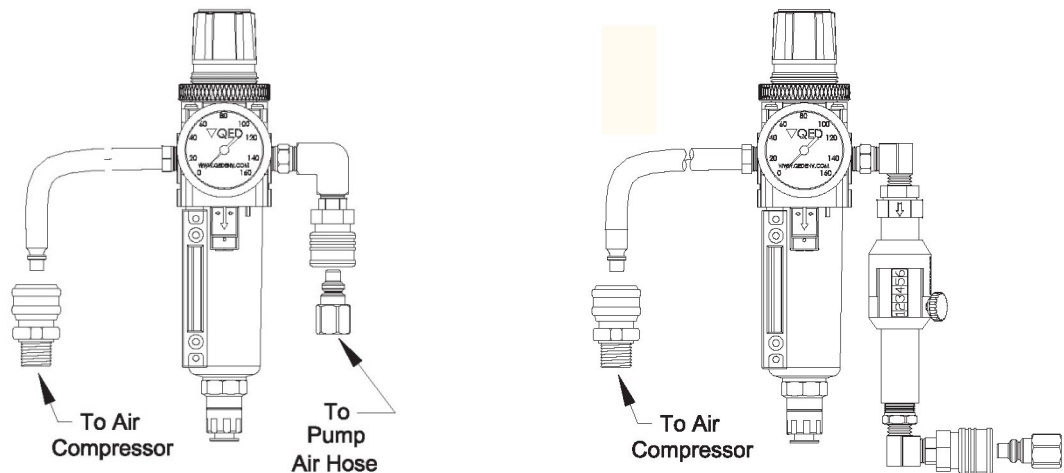

Part # 302468
For Standard Systems

Part # 302470
For Systems with Pump Cycle Counter

Maximum operating pressure 120 P.S.I. (8.4 Kg/cm²)

1. Cover the pump tubing/hose ends with tape if they are to be pulled through trenches or laid on the ground. This is to prevent debris from entering the lines.



2. Blow out all water and particles from compressed air conduits (including down well pump air supply lines) and fluid lines for at least 10 seconds after the water and particles exit before connecting them to the system.
3. Slip clamps over appropriate tubing/hose prior to connecting the tubing/hose to the pump barbs.

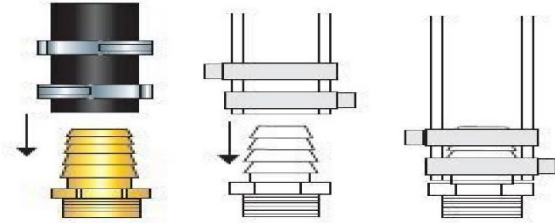

4. Push tubing/hose down flush with the fitting's nut if possible; cover at least three barbs if three or more are present (Note: when installing tubing in freezing weather, tubing can be dipped in warm water for a few seconds to soften the nylon).
5. Attach pump support rope/cable to the pump. "See figure 7"
6. Attach pump air supply and liquid discharge lines to the well cap. "See Figure 6". Attach the air exhaust line to the well cap if the pump air is to exhaust outside the well (Note: the liquid discharge line is always the largest diameter of the three lines, and the air supply line is always the smallest diameter).
7. Connect the pump air supply and liquid discharge lines to the appropriate surface lines/headers.
8. Turn on the air pressure to the pump (minimum of 0.5 psi per foot of vertical static head).



Caution: Submerging the pump before supplying it with air will result in fluid entering the exhaust tubing/hose. Those fluids will be discharged from the exhaust tubing/hose during the first few cycles of the pump. If this discharge will not be confined to the well; i.e., if the air exhaust line is routed outside the well*, it is important to make sure that the air exhaust line is not directed such that equipment/ personnel could be splashed by the discharged fluid when air is turned on to the pump.

Note: Submerging the pump before supplying it with air can also result in fluid entering the air supply line. This fluid from the well can contain particles, which could interfere with operation of the pump's air valve.

9. Lower the pump to the desired depth in the well.
10. Secure the pump by tying off the pump support line or by placing the well cap (or flange) on the well.



11. Increase the air pressure to the pump until the pump is pushing the fluid out at the desired rate. With sufficient air pressure (at least 10 to 15 psi higher than the vertical static head), the pump will gradually draw down the fluid level in the well to the level of the pump. The time required for this draw down varies with the yield of the well as compared to the flow rate of the pump. The maximum recommended pump operating pressure is 120 psi.



Note: If the well environment is such that deposition occurs on stainless steel parts, the operator may wish to raise the pump above the water level during a shutdown of the system.

*** Routing the air exhaust in vacuum wells:**

QED controllerless pumps automatically control the liquid level in the well. Under normal conditions, the liquid level will be maintained at a point approximately one foot below the top of a bottom load pump (this is the pump's actuation point). The pump will automatically start and stop as needed to maintain the level at this actuation point.

When QED controllerless pumps are used in wells that are under vacuum, and the exhaust air is routed into the well, the well level will be maintained at this normal actuation point. If, however, the well is under vacuum and the exhaust air is routed outside of the well (to atmospheric pressure), the actuation point of the pump will be higher than the normal actuation point by a distance equal to the amount of vacuum applied to the well (expressed in "inches of water column"). Please note that the pump will still function normally and maintain the liquid level, albeit a higher level.

Hose Bundles

Hose bundling or the use of jacketed tubing reduces equipment entanglement at the well surface, and aids the removal of the pump from the well. Bundling also assists in positioning the pump and down-well hose assembly against one side of the well casing. Maximum space is created for other items, such as probes, to be periodically placed inside the well.

Follow these instructions to create a hose bundle:

1. Lay the equipment on the ground and make all of the necessary hose connections. (**See Figure 4**).
2. If a well cap is supplied, install it on the hoses. (**See Figure 4**).
3. Connect the quick-link assembly on the support rope to the eyebolt on the AP4+ and lay the support rope out along with the hoses. Make sure that none of the hoses or support ropes are crossing over each other (**See Figure 7**).

Note: To make the next step easier, pull the support rope and the hoses taut.

4. Starting at the AutoPump end of the hose, put a tie-wrap through the center of the braided support rope just above the uppermost quick-connect or barb on the AutoPump (**See Figure 7**).
5. Pulling the rope taut, put the tie-wrap around the fluid discharge hose with the rough surface outwards. Cross the ends and complete the connect the tie-wrap make sure it is straight and is not kinking the hoses (**See Figure 7**).

Note: After completing this step, the fluid discharge hose will be attached to the support rope and the exhaust hose. At this point the air supply hose is still lying free.

6. Place the next tie-wrap two feet towards the well cap from the first. Secure the air supply hose rather than the exhaust hose.

Note: It is important to put the tie-wraps approximately two feet apart to keep a proper discharge hose/support rope bundle. Experience has shown that spreading the tie-wraps further apart than two feet increases the probability for hose kinking.

7. Continue to alternate the air exhaust and the air supply tie-wraps every two feet, stopping about five feet from the wellhead.
8. Being careful not to leave any sharp edges, cut the excess from the tie-wraps.

You now have a down-well bundled hose assembly that supports both the hoses and the down-well equipment.

Figure 6 - Examples of Well Caps

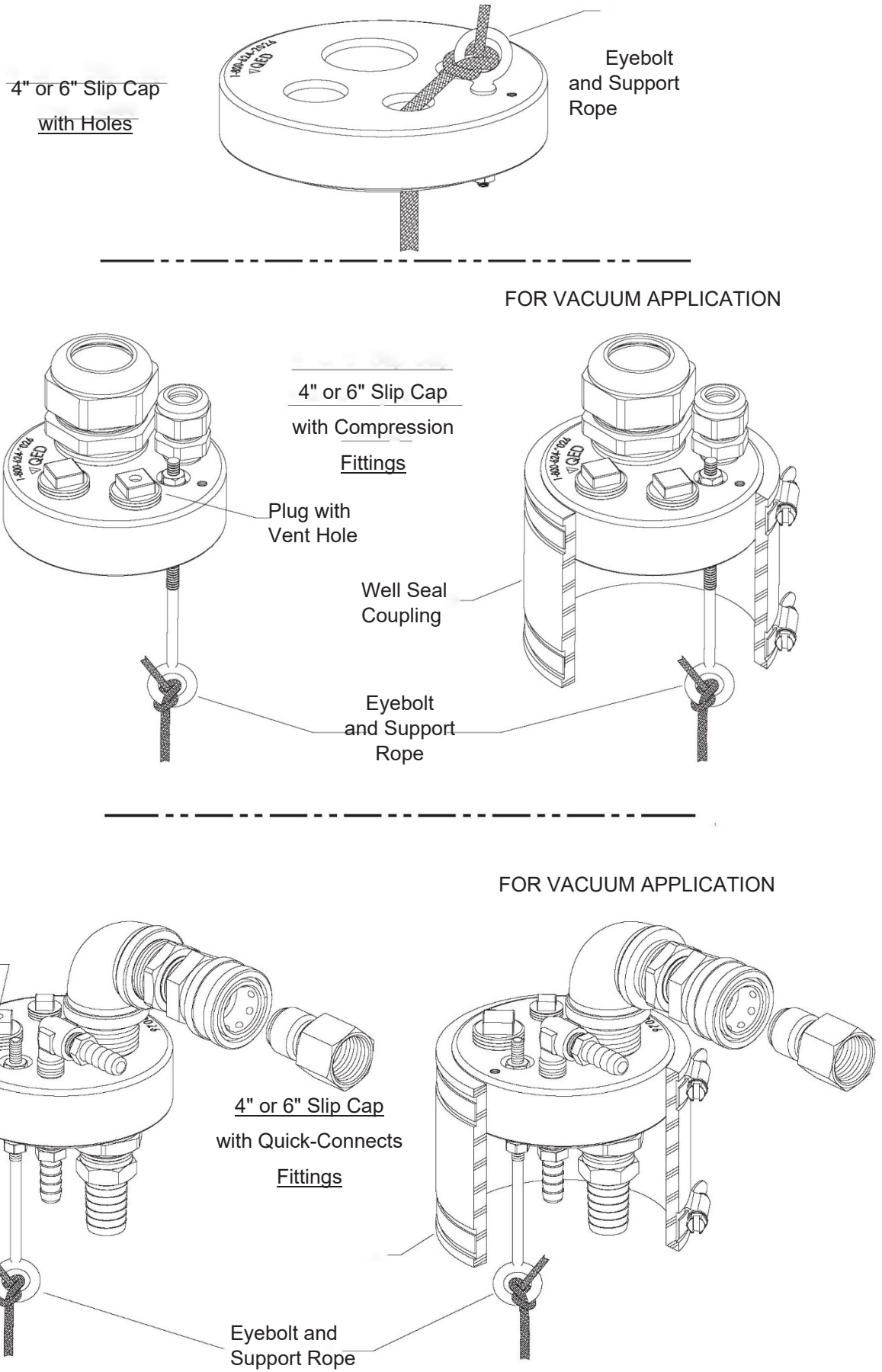
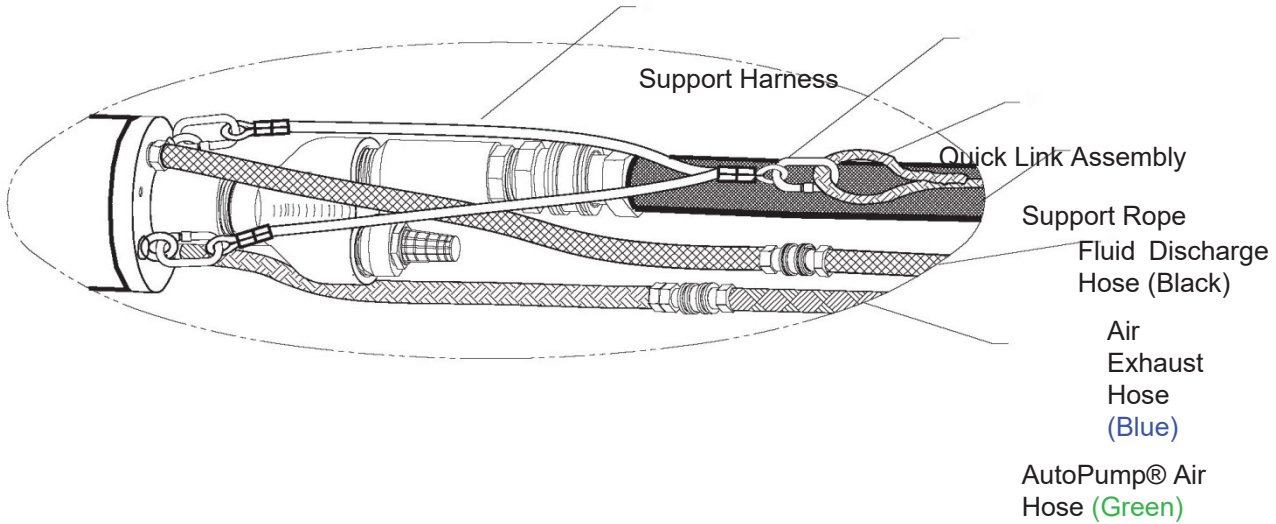
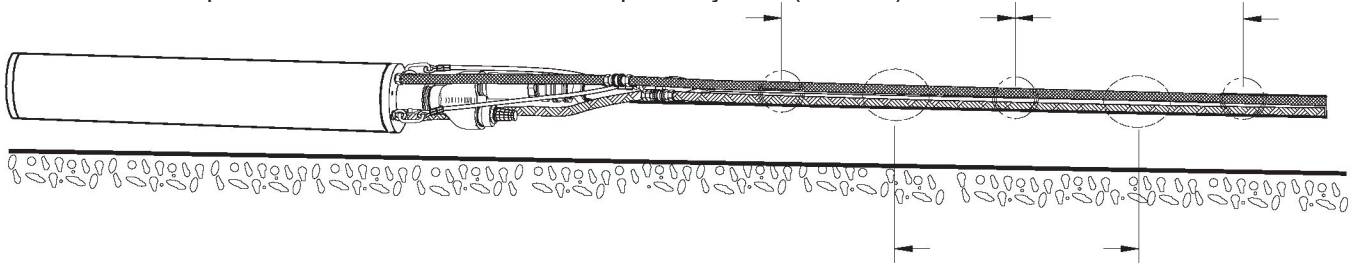

Figure 7 - Hose Bundling



Air Exhaust Tie-Wraps in Between Air Exhaust Tie-Wraps Every 4 Ft. (122 Cm)



Air Exhaust Tie-Wraps in Between Air Hose Tie-Wraps Every 4 Ft. (122 Cm)

Tie-Wrap Detail

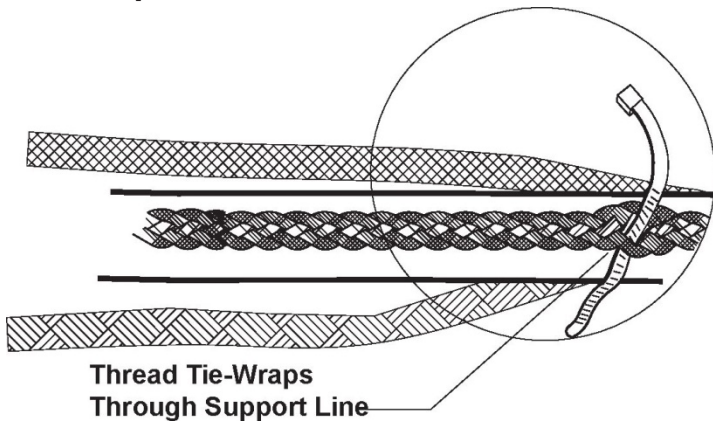

Air Exhaust Tie-Wrap

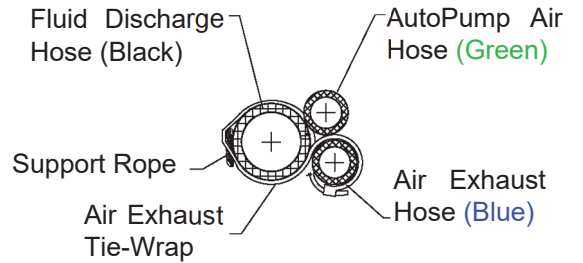

Air Hose Tie-Wrap

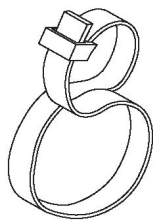
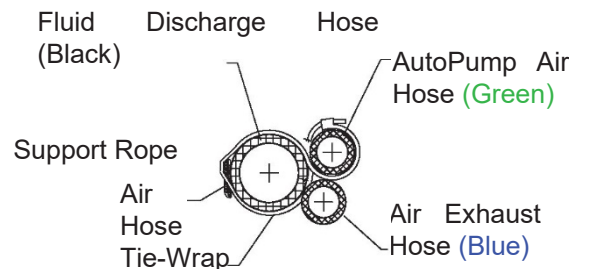

Figure 8 Tie-Wrap Layout

Cleaning the AutoPump Ultra 4.0



Caution: Wear goggles, gloves, and coveralls when servicing this system.

Note: The Ultra 4.0 uses non-stick finishes on the float and discharge tube. To protect these finishes, **never use any type of abrasive pad, wire brush, steel wool or sandpaper to clean these two components.**

Removing the Pump's Casing

1. Disconnect the air supply from the pump.
2. Remove the bolt at the bottom of the pump which holds the inlet screen in place (bottom loading pumps only).
3. Remove the three bolts at the bottom of the pump which hold the inlet in place (See Figures 8 and 9).
4. Remove the inlet from the pump's casing by pulling it out.
5. Twist and slide the casing down off the pump's frame.

Cleaning the Pump Interior

The inner workings of the pump should now be exposed for inspection and cleaning (See Figures 8 and 9). Gently brush off built-up solids from the float, discharge tube, pump casing and control rod.

Mineral Build-up Cleaning Procedure

1. The bottom "spider" casting should be removed by unthreading it from the discharge tube. (See Figures 8 and 9).
2. Visually inspect the fluid discharge pipe for scale build-up or debris. Also, do the same with the float that slides up and down on the discharge tube.
3. Should there be scale deposits on either the discharge tube or float, remove the float from the discharge tube as follows: (See Figures 8 and 9) Remove the small steel hairpin from the bottom spring cup. Removing the hairpin and spring cup will allow you to remove the spring, sliding stop and float from the SS discharge pipe.
4. The fluid discharge tube can now be cleaned using a damp cloth. To aid in cleaning, the discharge tube can be soaked in vinegar. To remove tougher build-up, scour pads that are made for non-stick cookware can be used.
5. Both the internal and external surfaces of the float can be cleaned using a damp cloth. To aid in cleaning, the float can be soaked in vinegar. To remove tougher build-up, scour pads that are made for non-stick cookware can be used. The float end plates can be removed to ease cleaning. After cleaning, the plates should be replaced on the same end of the float from which they came.
6. The white plastic square control rod is the next component to be cleaned. The control rod is the item that fits through the smaller hole in the float plate and is adjacent to the discharge tube in the assembled pump. To clean the control rod, use an abrasive pad or a razor or utility knife (not sandpaper).
7. The final component to be cleaned is the outer casing. The fastest and most effective way to clean out the inside surface of the pump casing is to use a three-stone honing tool. The technique is to move the hone in and out a half dozen times or so, through each end of the casing. The time for the casing cleaning should take no longer than 5 minutes.

The AutoPump is now ready for re-assembly by following the steps above in reverse order.

Note: Before threading the bottom "spider" onto the pump's discharge tube, be sure to wrap the discharge tube's threads completely with Teflon tape.

Note: Before inserting the two assemblies back into the pump's casing, apply PTFE grease to the two o-rings (#16 on the next page) to make the next disassembly easier.

Figure 8 - Exploded View of Bottom-Loading Ultra (Long and Short)

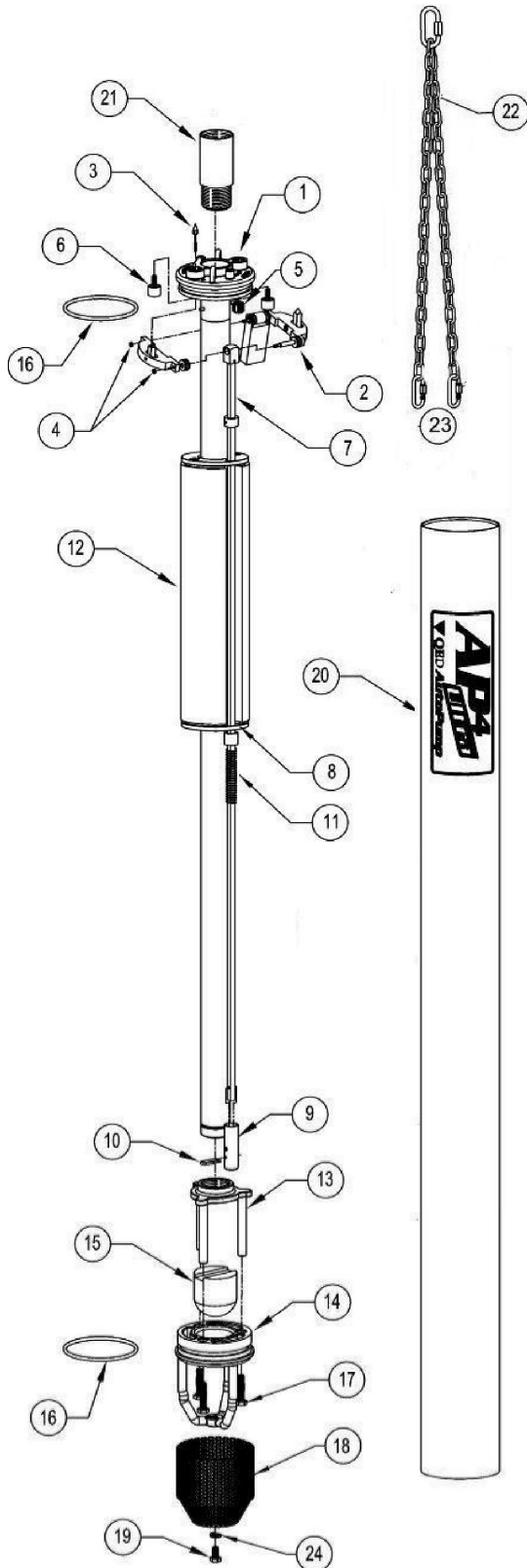

303223P AND 303211P

ITEM NO.	PART NUMBER	DESCRIPTION	QTY.
1	303221	FRAME AP4+ LONG 316SS W/120 PSI SEAT AND PIVOT PIN AND CLG-EP TUBE	1
	303214	FRAME AP4+ SHORT 316SS W/120 PSI SEAT AND PIVOT PIN AND CLG-EP TUBE	
2	303204	AP4 LEVERS ASSY PVDF W/POPPET-PIN BUSHING	1
3	201614	POPPET INTAKE 120 PSI AP4 316SS	1
4	202889	NUT SMALL PATTERN, 4-40, LEVER CONNECTOR 316SS	2
5	201621	SEAT EXHAUST 120 PSI AP4 316SS	1
6	301083	AP4 212 DEG 316 SS MAGNET W/EPOXY	2
7	303087	CTRL ROD ASSY LONG AP4+ 316SS	1
	303088	CTRL ROD ASSY SHORT AP4+ 316SS	
8	201210	AP-4 CONTROL ROD SLIDING STOP PVDF	1
9	201211	AP4 PVDF (KYNAR) SPRING CUP	1
10	206247	HAIRPIN, AP4 CTRL ROD/SPRING CUP PIN HASTELLOY C276	1
11	200351	SPRING AP4 CTRL ROD HASTELLOY C-276	1
12	303209	FLOAT ASSY AP4, COATED AND NONMETALLIC CONTACTS	1
13	206195	SPIDER, CASTING - AP4+ MACHINED 316LS	1
14	206187	INLET CASTING - AP4+ MACHINED 316LS	1
15	206417	PLUG BCV INTAKE AP4 BL UHMW-PE	1
16	206273	O-RING PARKER VITON 2-235 V747-75	2
17	206362	SCREW, 1/4"-20 X 1-1/4" FL/THR HEX CAP, W/VIT, WA/IBRA-TITE	3
18	206198	SCREEN ANGLE, AP4+ 316LS	1
19	206289	SCREW, 1/4-20 X1/2" LONG HEX HD CAP - 316SS	1
20	206592	CASING, FRP AP4 ULTRA LONG LABELED	1
	206591	CASING, FRP AP4 ULTRA SHORT LABELED	
21	205601	HOUSING CHECK DISCHARGE 316SS	1
22	300984	HARNESS SUPP 316SS CHAIN	1
23	202515	QUICK LINK 3/16" 316SS	2
24	202886	WASHER SPLIT LOCK 1/4" 316SS	1

Figure 9 - Exploded View of Top-Loading Ultra (Long and Short)

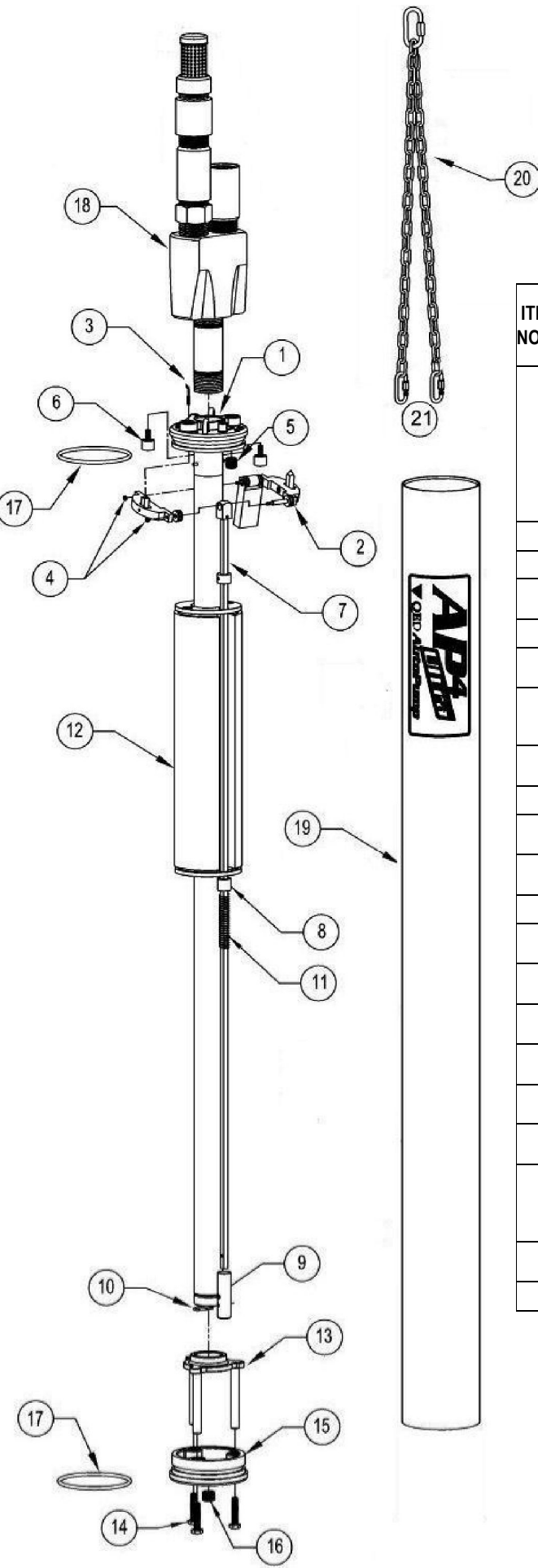

ITEM NO.	PART NUMBER	DESCRIPTION	QTY.
1	303221	FRAME AP4+ LONG 316SS W/120 PSI SEAT AND PIVOT PIN AND CLG-EP TUBE	1
	303214	FRAME AP4+ SHORT 316SS W/120 PSI SEAT AND PIVOT PIN AND CLG-EP TUBE	
2	303204	AP4 LEVERS ASSY PVDF W/POPPET-PIN BUSHING	1
3	201614	POPPET INTAKE 120 PSI AP4 316SS	1
4	202889	NUT SMALL PATTERN, 4-40, LEVER CONNECTOR 316SS	2
5	201621	SEAT EXHAUST 120 PSI AP4 316SS	1
6	301083	AP4 212 DEG 316 SS MAGNET W/EPOXY	2
7	303087	CTRL ROD ASSY LONG AP4+ 316SS	1
	303088	CTRL ROD ASSY SHORT AP4+ 316SS	
8	201210	AP-4 CONTROL ROD SLIDING STOP PVDF	1
9	201211	AP4 PVDF (KYNAR) SPRING CUP	1
10	206247	HAIRPIN, AP4 CTRL ROD/SPRING CUP PIN HASTELLOY C276	1
11	200351	SPRING AP4 CTRL ROD HASTELLOY C-276	1
12	303209	FLOAT ASSY AP-4, COATED AND NONMETALLIC CONTACTS	1
13	206195	SPIDER, CASTING - AP4+ MACHINED 316LS	1
14	206252	SCREW, 1/4"-20 X1-1/4" FL/THR HEX CAP, W/VIT, W/VIBRA-TITE	3
15	206263	INLET, CASTING-MACHINED AP4+ TOP FILL 304LSS	1
16	206290	PLUG, 1/4" 316SS COUNTERSUNK HEX	1
17	206273	O-RING PARKER VITON 2-235 V747-75	2
18	303091	AP4+TL WYE ASSY W/316SS DCV, 316SS CREEN	1
19	206592	CASING, FRP AP4 ULTRA LONG LABELED	1
	206591	CASING, FRP AP4 ULTRA SHORT LABELED	
20	300984	HARNESS SUPP316SS CHAIN	1
21	202515	QUICK LINK 3/16" 316SS	2

303223P AND 303211P

FIGURE 10: EXPLODED VIEW OF BOTTOM-LOADING ULTRA 4.0 250°F (LONG & SHORT)

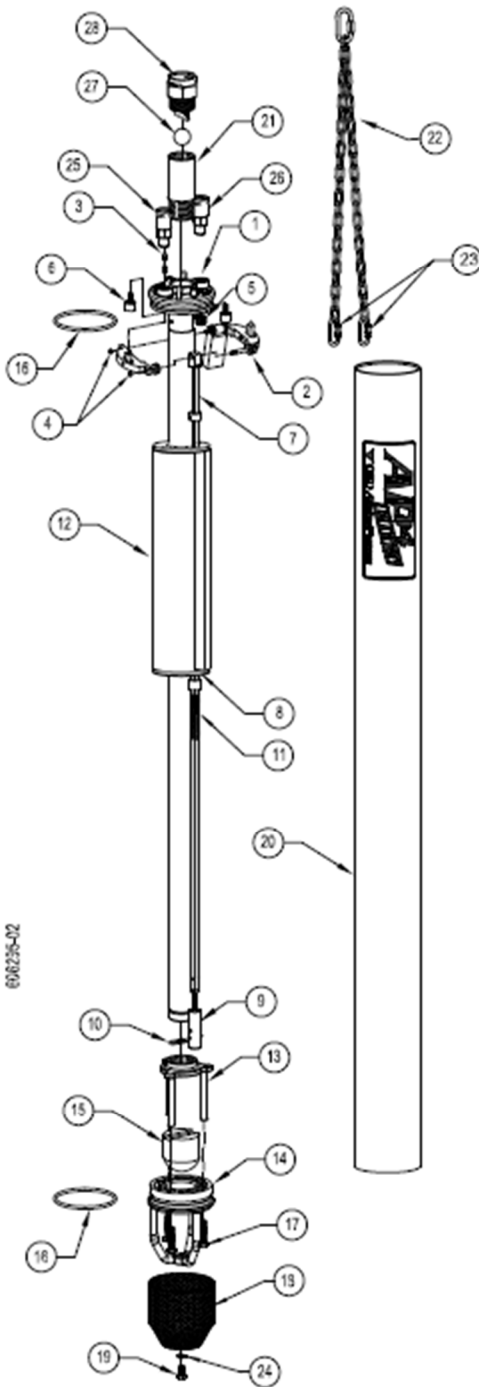

ITEM NO.	PART NUMBER	DESCRIPTION	QTY.
1	303221	FRAME AP4+ LONG 316SS W/120 PSI SEAT AND PIVOT PIN AND CLG-EP TUBE	1
	303214	FRAME AP4+ SHORT 316SS W/120 PSI SEAT AND PIVOT PIN AND CLG-EP TUBE	
2	303204	AP4 LEVERS ASSY PVDF W/POPPET+PIN BUSHING	1
3	201614	POPPET INTAKE 120 PSI AP4 316SS	1
4	202889	NUT SMALL PATTERN, 4-40, LEVER CONNECTOR 316SS	2
5	201621	SEAT EXHAUST 120 PSI AP4 316SS	1
6	301083	AP4 212 DEG 316 SS MAGNET W/EPOXY	2
	303087	CTRL ROD ASSY LONG AP4+ 316SS	
7	303088	CTRL ROD ASSY SHORT AP4+ 316SS	1
9	201210	AP-4 CONTROL ROD SLIDING STOP PVDF	1
9	201211	AP4 PVDF (KYNAR) SPRING CUP	1
10	206247	HARFIN, AP4 CTRL ROD/SPRING CUP PIN HASTELLOY C276	1
11	200351	SPRING AP4 CTRL ROD HASTELLOY C-276	1
12	303210	COATED HIGH TEMPERATURE FLOAT ASSEMBLY	1
13	206195	SPIDER, CASTING - AP4+ MACHINED 316LS	1
14	206187	INLET CASTING - AP4+ MACHINED 316LS	1
15	206417	PLUG BCV INTAKE AP4 BL UHMW-PE	1
16	206273	O-RING PARKER VITON 2-225 V747-75	2
17	206362	SCREW, 1/4"-20 X 1-1/4" FL/THR HEX CAP, W/VT, W/VIBRA-TITE	3
18	206198	SCREEN ANGLE, AP4+ 316LS	1
19	206289	SCREW, 1/4"-20 X 1/2" LONG HEX HD CAP - 316SS	1
20	206589	CASING, 316 SS AP4 ULTRA LONG LABELED	1
	206588	CASING, 316 SS AP4 ULTRA SHORT LABELED	
21	205601	HOUSING CHECK DISCHARGE 316SS	1
22	300084	HARNES SUPP 316SS CHAIN	1
23	202515	QUICK LINK 3/16" 316SS	2
24	202886	WASHER SPLIT LOCK 1/4" 316SS	1
25	206210	HOUSING EASY-FITTING AIR 1/4 MPT	1
26	206213	HOUSING EASY-FITTING EXH 1/4 MPT	1
27	201852	BALL 7/8 GRADE 1 TEFLON	1
28	206216	HOUSING ADAPTER EZ-FITTING DISCHARGE 1" MPT	1

303276P AND 303277P

FIGURE 11: EXPLODED VIEW OF TOP-LOADING ULTRA 4.0 250°F (LONG & SHORT)

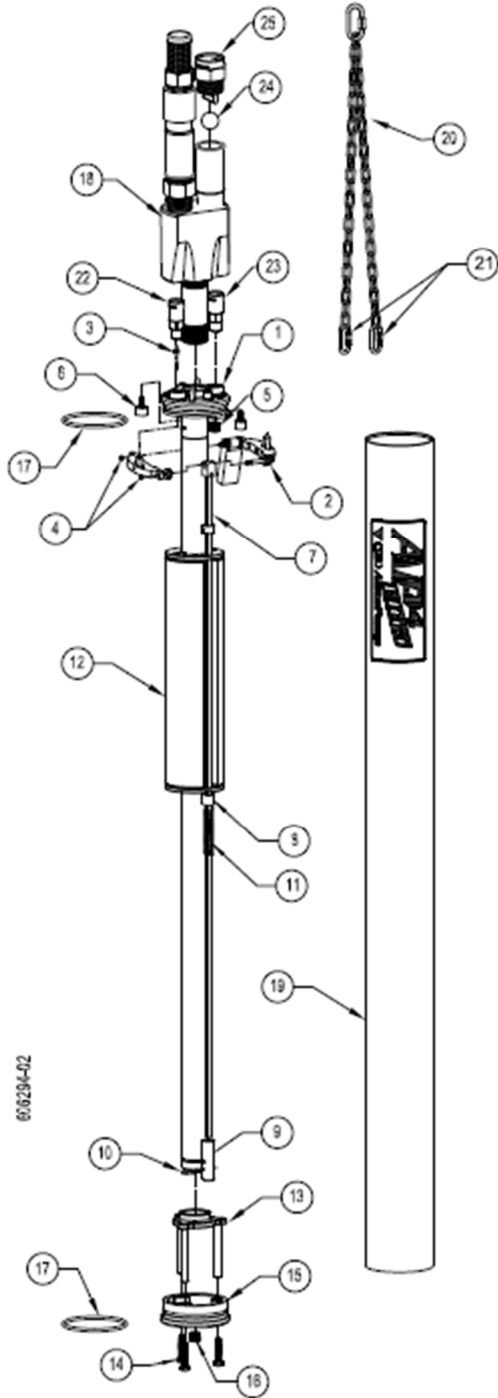

ITEM NO.	PART NUMBER	DESCRIPTION	QTY.
1	303221	FRAME AP4+ LONG 316SS W/120 PSI SEAT AND PIVOT PIN AND CLG-EP TUBE	1
	303214	FRAME AP4+ SHORT 316SS W/120 PSI SEAT AND PIVOT PIN AND CLG-EP TUBE	
2	303204	AP4 LEVERS ASSY PVDF W/POPPET-PIN BUSHING	1
3	201614	POPPET INTAKE 120 PSI AP4 316SS	1
4	202889	NUT SMALL PATTERN, 4-40, LEVER CONNECTOR 316SS	2
5	201621	SEAT EXHAUST 120 PSI AP4 316SS	1
6	301083	AP4 212 DEG 316 SS MAGNET W/IEPOXY	2
7	303087	CTRL ROD ASSY LONG AP4+ 316SS	1
	303088	CTRL ROD ASSY SHORT AP4+ 316SS	
8	201210	AP-4 CONTROL ROD SLIDING STOP PVDF	1
9	201211	AP4 PVDF (KYNAR) SPRING CUP	1
10	206247	HAIRPIN, AP4 CTRL ROD/SPRING CUP PIN HASTELLOY C276	1
11	200351	SPRING AP4 CTRL ROD HASTELLOY C-276	1
12	303209	COATED HIGH-TEMPERATURE FLOAT ASSEMBLY	1
13	206195	SPIDER, CASTING - AP4+ MACHINED 316LS	1
14	206362	SCREW, 1/4"X20 X 1-1/4" FL/THR HEX CAP, W/VIT, W/MBRA-TITE	3
15	206263	INLET, CASTING-MACHINED AP4+ TOP FILL 304LSS	1
16	206290	PLUG, 1/4" 316SS COUNTERSUNK HEX	1
17	206273	O-RING PARKER VITON 2-235 V747-75	2
18	303091	AP4-TL WYE ASSY W/316SS DCV, 316SS CREEN	1
19	206589	CASING, 316 SS AP4 ULTRA LONG LABELED	1
	206588	CASING, 316 SS AP4 ULTRA SHORT LABELED	
20	300984	HARNES SUPP 316SS CHAIN	1
21	202515	QUICK LINK 3/16" 316SS	2
22	206210	HOUSING EASY-FITTING AIR 1/4 MPT	1
23	206213	HOUSING EASY-FITTING EXH 1/4 MPT	1
24	201852	BALL 7/8 GRADE 1 TEFLON	1
25	206216	HOUSING ADAPTER E-Z FITTING DISCHARGE 1" MPT	1

303280P AND 303281P

FIGURE 12: EXPLODED VIEW OF BOTTOM-LOADING ULTRA 4.5 180°F & 250°F

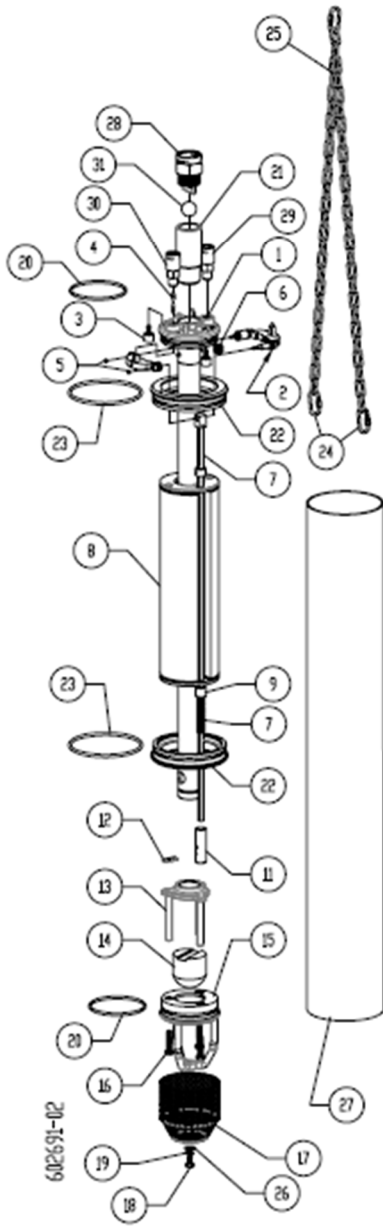

ITEM	PART #	DESCRIPTION	QTY.
1	303214	FRAME POLISHED AP4+ SHORT 316LSS W/120 PSI SEAT AND PIVOT PIN	1
2	303204	AP4 LEVER ASSY PVDF W/POPPET BUSHING	1
3	301063	AP4 212 DEG 316 SS MAGNET W/EPOXY	2
4	201614	POPPET INTAKE 120 PSI AP4 316SS	1
5	202889	NUT SMALL PATTERN, 4-40, LEVER CONNECTOR, 316SS	2
6	201621	SEAT 120PSI EXHAUST AP4 316 SS	1
7	303068	CTRL ROD ASSY SHORT AP4+ 316SS	1
8	303270	FLOAT COATED 4-1/2 PUMP ASSY	1
	303311	FLOAT COATED 4-1/2 HIGH TEMP, PUMP ASSY	
9	201210	AP-4 CONTROL ROD SLIDING STOP PVDF	1
10	200351	SPRING AP4 CTRL ROD HASTELLOY C-276	1
11	201211	AP4 PVDF (KYNAR) SPRING CUP	1
12	206247	HAIRPIN, AP4 CTRL ROD/SPRING CUP PIN HAST.	1
13	206195	SPIDER, CASTING -AP4+MACHINED 316LSS	1
14	200357	PLUG BCV INTAKE AP4 BL UHMWPE	1
15	206167	INLET, CASTING -AP4+ MACHINED 316SS	1
16	206362	SCREW, 1/4"-20 X 1-1/4" FL/THR HEX CAP, W/VIT, W/VIBRA-TITE	3
17	206198	SCREEN ANGLE, AP4+ 316LS	1
18	206289	SCREW, 1/4-20 X 1/2" LONG HEX HD CAP • 316SS	1
19	202886	WASHER 1/4 SPLIT LOCK 316 SS	1
20	206273	O-RING PARKER VITON 2-235 V747-75	2
21	205601	HOUSING, CHECK 1" MPT x 1" FPT 316 S.S.	1
22	206450	RING LOWER AP4 ULTRA W/4.5 OD CASING	2
23	202901	O-RING PARKER 2-242 VITON V747-75	2
24	202515	QUICK LINK 3/16" 316 SS	2
25	300964	HARNES SUPPORT 316SS CHAIN	1
26	206437	WASHER 1/4 FLAT 316 SS	1
27	206570	CASING, FIBERGLASS 32.25" LONG YELLOW	1
	206781	CASING, 316 SS 32.25" LONG HIGH TEMPERATURE	
28	206216	HOUSING, ADAPTER EZ-FITTINGS DISCHARGE 1" MPT	1
29	206213	HOUSING EASY-FITTING EXH 1/4 MPT	1
30	206210	HOUSING EASY-FITTING AIR 1/4 MPT	1
31	201852	BALL 7/8 GRADE 1 TEFLON	1

303269P AND 303312P

Figure 13 - Exploded View of AP Ultra Lever Assembly

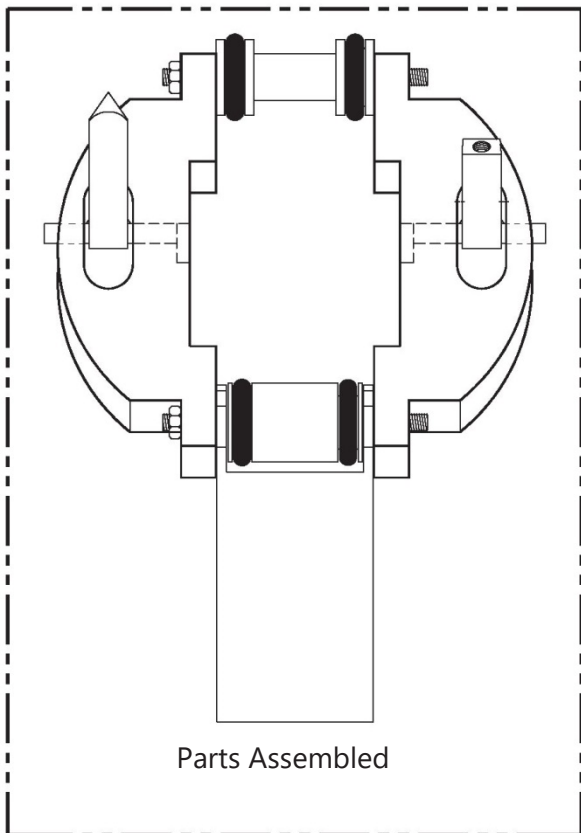
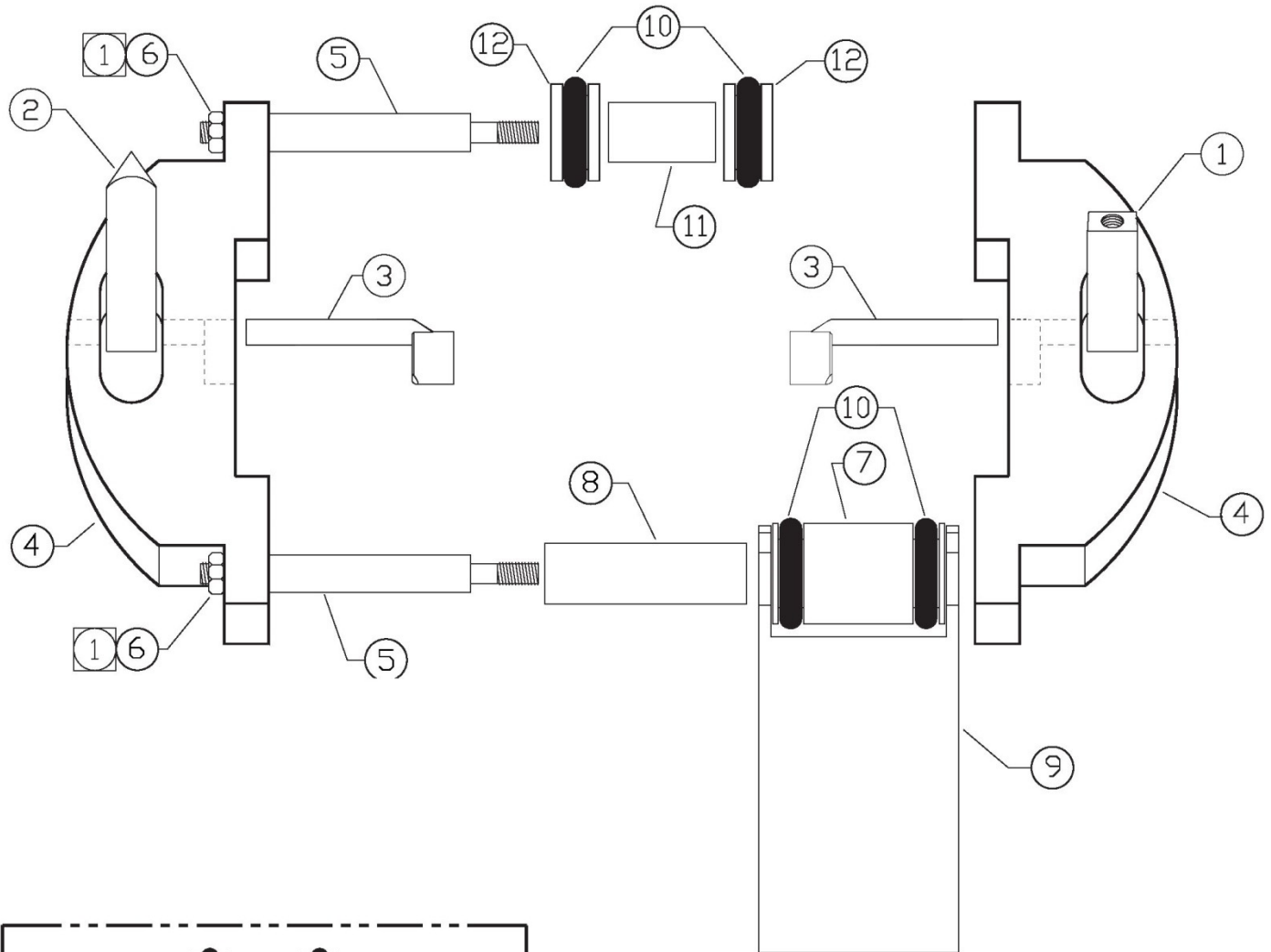

ITEM NO.	PART NUMBER	DESCRIPTION	QTY.
1	201616	120 P.SI INTAKE POPPET CONNECTOR-LONG	1
1	201616	120 P.SI INTAKE POPPET CONNECTOR-SHORT	1
2	201623	316 SS 120 P.SI EXHAUST POPPET-LONG	1
2	201623	316 SS 120 P.SI EXHAUST POPPET-SHORT	1
3	206445	NITRONIC 60 POPPET PIN-BUSHING	2
4	201033	LEVER HALF	2
5	201626	316 SS LEVER CONNECTING PIN	2
6	202889	316 SS LEVER CONNECTING NUT	4
7	200330	17-7 COUNTERWEIGHT ROLLER	1
8	201053	316 SS COUNTERWEIGHT BUSHING	1
9	201520	316 SS COUNTERWEIGHT-LONG	1
9	201520	316 SS COUNTERWEIGHT-SHORT	1
10	200496	VITON BUMPER O-RING	4
11	201052	316 SS CONTROL ROD ADAPTER BUSHING	1
12	201458	PVDF CONTROL ROD ROLLER	2

Figure 14 - Exploded View of 1 Inch Check Valve

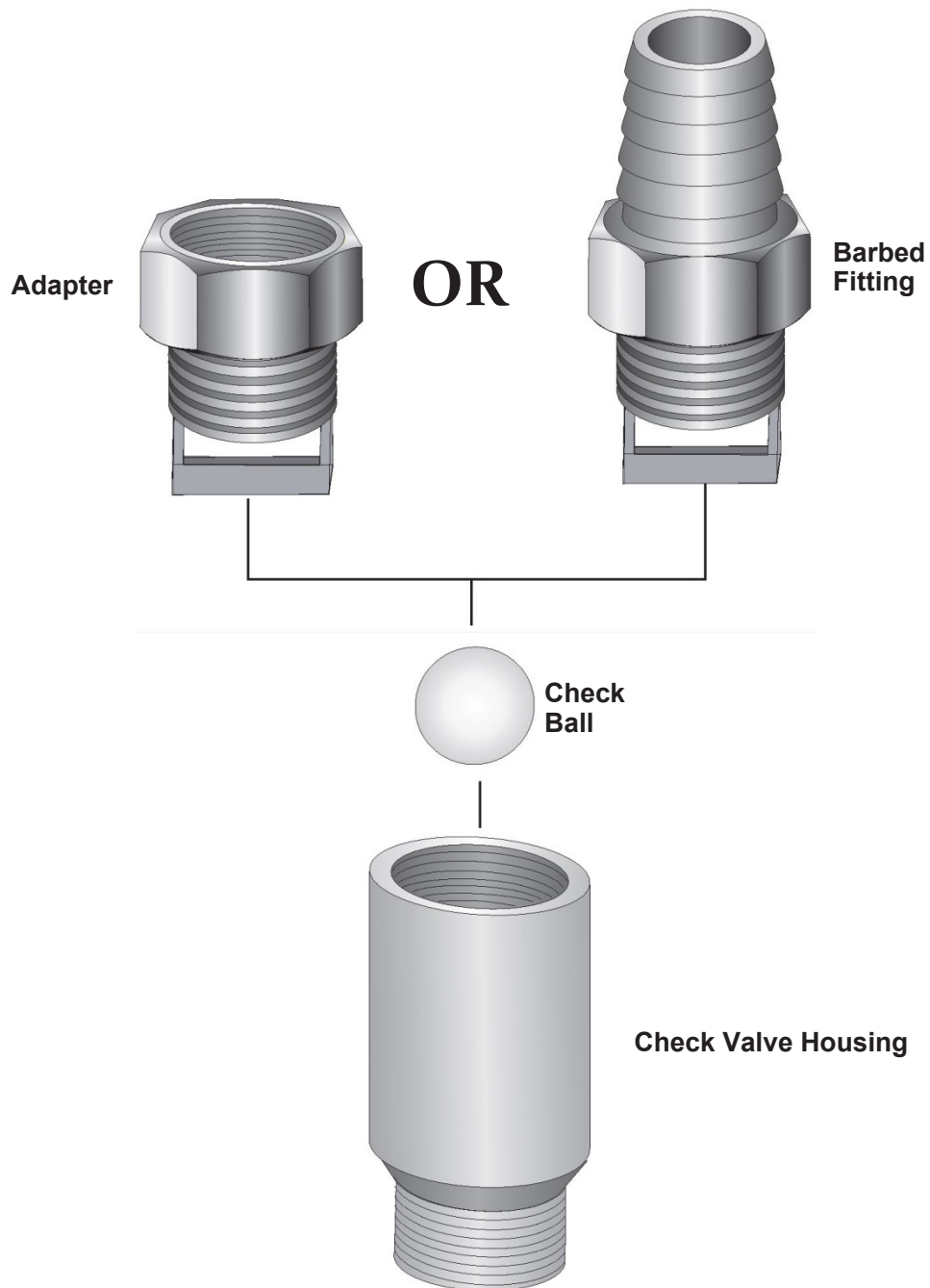

Problems may occur and usually can be easily resolved by following these instructions. If, after careful reading and service, you cannot resolve the problem, please contact the QED Environmental Systems (QED) Service Department at (800) 537-1767.



Caution: Wear goggles, gloves, and coveralls when servicing this system. After troubleshooting is completed and before assembling the pump, slowly move the float through its range to ensure that the lever will trip even if the pump fills and empties slowly.

Possible Causes	Symptoms		
	Pump Not Cycling	Pump Not Cycling, Volume is Reduced or There is No Discharge	Air in Fluid or Discharge
1. Air Supply	X		X
2. Fluid Level	X		
3. Air Exhaust Restricted	X		X
4. Fluid Inlet Clogged	X		
5. Debris, Scale or Very Viscous Fluid	X	X	X
6. Lever Pivot Wear	X		X
7. Debris in Air Inlet Valve	X		
8. Fluid Check Valve		X	
9. Valve Timing	X		

Troubleshooting

1. Air Supply

- If the air pressure is too low, or if the flow is severely restricted, the pump will not cycle. The minimum air pressure requirement for pump operation is 0.5 psi(.03 Bar) per foot(30cm) of vertical static head.
- If the air pressure exceeds the design limitations of the pump, the pump may fail to cycle, or the exhaust may have locked up and caused air to enter the fluid discharge.

2. Fluid Level

- The fluid level must be above the fluid inlet on a Top-Loading pump. On a Bottom-Loading pump, the fluid must be no lower than 9 inches below the head of the pump

3. Air Exhaust Restricted

- The exhaust line must not be kinked, plugged, or too small in diameter.
- The air exhaust outlet must be above the fluid level
- If the air exhausts in the well, the well must be vented to the atmosphere or a functioning vapor recovery line.

- If the air exhausts to the atmosphere (outside the well) and a vacuum is drawn on the well, the pump may fail to fill. In order for the pump to fill under these conditions, the pump must be submerged to make up for the pressure difference between the atmosphere and the partial vacuum in the well.

The pressure difference, expressed as feet(cm) of water column (FT. W. C.), is the distance the fluid must be above the pump before it can fill.

4. Fluid Inlet Clogged

- If the fluid inlet screen is clogged with debris water cannot enter the pump.

5. Debris, Scale, or very Viscous Fluid

- If debris, scale or a very viscous fluid has accumulated inside the pump, the float may not move freely up and down, or the control rod may not slide easily through the float.
- Clean the float, control rod, and the casing. (See **Chapter 6 for cleaning instructions**).

6. Lever Pivot Wear

- Grasp the center of the lever with thumb and forefinger. Rotate the lever to horizontal.
- Push up and down, toward and away from the head. Confirm that there is less than 1/32 inch(0.76mm) of movement.
- Replace the levers if the pivot hole is worn

7. Debris in Air Inlet Valve (First check #6-Lever Pivot Wear)

- Open the pump. Connect the air supply. Pull the control rod down. Listen to determine if air leaks through. If air still leaks through the valve with the control rod down, the air tubing must be removed to access the valve inlet to check for debris in the valve. Clean the valve by blowing air or water through it from both ends.
- Push the rod upwards. If little or no air passes through, remove the tubing to access the valve inlet. Blow air through the valve from the poppet side to clear debris from the ball and seat.

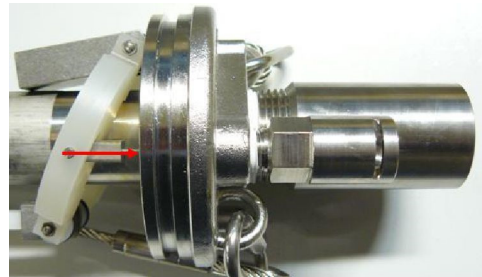
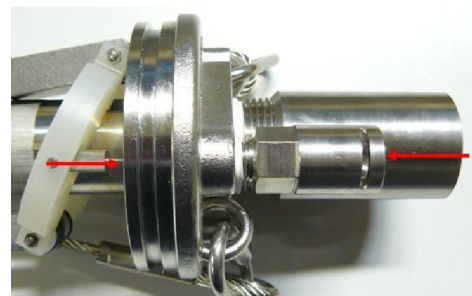

8. Fluid Check Valves

- Open the pump. Hold the pump vertically and pour water into the discharge check valve. If water flows through, clean the valve.
- Remove the valve and use emery cloth or a very fine sand paper to polish the surface where the ball seats.
- If the pump is a Bottom-Loading design, inspect the seat of the bottom check valve for debris and wear. Clean or replace if necessary.
- If the pump is a Top-Loading design, remove the fluid inlet check valve and inspect the seating surface and the ball for debris and wear.

9. Air Inlet Valve Timing

- (First check lever pivot wear per #6 above)
- Call the QED Service Department for correct air valve timing for your pump.

Returning Equipment for Service

If the equipment needs to be returned to QED for servicing, please follow these steps:

1. Call the QED Service Department and obtain a Return Material Authorization (RMA) number. Please have available the contact person's name, company name and address, phone number, fax number, reason for the return, and the names of the chemicals to which the equipment has been exposed.
2. Clean all equipment before shipping. (See **Equipment Cleaning Requirements at the end of this section**). If the equipment must be cleaned after it arrives at QED, the customer will be charged for the cleaning and disposal of material, if necessary. (Cost can be \$500.00 per piece of equipment cleaned.) It is also important to note that shipping equipment with a known hazardous waste is a *violation of federal law*. Drain and dry all equipment after cleaning.
3. Package the equipment so that it will not be damaged in shipment. Use bubble pack rather than Styrofoam flakes as packing material.
4. Ship the equipment via a carrier and service level (i.e., one-day, two-day shipping) in consideration of probable service time and return shipment time.
5. It is recommended that such shipments be insured so, if the shipment is badly damaged or lost, the customer can replace the equipment at little or no cost.
6. Include the contact's name, company, phone number and RMA number given by QED.
7. Write the RMA number on the outside of the packaging so it will be directed immediately to the QED Service Department.

Equipment Cleaning Requirements

If the equipment is to be shipped to another site or to the factory for service, it needs to be thoroughly cleaned before leaving the site. Cleaning the equipment protects the user (sender), the shipper, and the receiver from dirt and/or contaminants. If the equipment is not cleaned prior to shipping for servicing, it may be severely delayed, refused or the shipper may be charged a cleaning fee. Before packing and shipping, ensure that the equipment is dry inside and out.

To Clean the AP Ultra:

1. Pump clean water or water with a gentle soap solution (e.g. Dish Soap) through the pump to remove free product and particles.
2. Rinse all soap off of the equipment.
3. Soak and rinse the outside of the unit with water to remove loose debris and dirt.
4. Pressure wash inside and out to remove difficult dirt and contaminants.

Caution: Use low pressure (less than 40 psi (2.76 bar)) when pressure washing.

Bottom Inlet, Long

Max. Flow 14 gpm (53 lpm)*

O.D. 3.6 in. (9.1 cm)

Length 51.4 in. (131 cm)



Description

The AutoPump Ultra 4.0 Bottom Inlet Long provides maximum capabilities and flow in a bottom inlet pump for 4" (100 mm) diameter and larger wells. The base model delivers flow rates up to 14 gpm (53 lpm)*. The Ultra 4.0 uses proprietary non-stick finishes on the float and discharge tube to reduce solids buildup, extending the time between cleaning and making it much faster and easier to clean the pump. All metallic parts are 316-grade Stainless Steel, which has greater corrosion resistance and can withstand attacks of the harshest leachate.

The AP4.0 Bottom Inlet Long pump is complemented by the most comprehensive selection of accessories to provide a complete system to meet site-specific requirements. Call QED for prompt, no-obligation assistance on your pumping project needs.

The AutoPump Heritage

The AutoPump Ultra 4.0 Bottom Inlet Long is part of the famous AutoPump family of original automatic air-powered pumps, developed in the mid 1980s specifically to handle unique pumping needs at remediation and landfill sites. Over the years they've proven their durability at thousands of sites worldwide. AutoPumps are designed to handle difficult pumping challenges that other pumps can't, such as hydrocarbons, solvents, suspended solids, corrosives, temperature extremes, viscous fluids and frequent start/stop cycles. Beyond just the pump, AutoPump systems offer the most complete range of tubing, hose, connectors, wellhead caps and accessories to help your installation go smoothly. This superior pumping heritage, application experience and support back up every AutoPump you put to work on your project.

Advantages

1. **The original automatic air-powered well pump, proven worldwide over 30 years.**
2. **Proprietary finishes extend the time between cleaning.**
3. **All metallic parts are 316-grade SS for better corrosion resistance.**
4. **New and improved valve stem connections have no fasteners, or cotter pins. Exhaust seat is easy to adjust.**
5. **Temperature ratings up to 250 °F, making it ideal for high temperature applications.**
6. **Five-year warranty.**

Bottom Inlet, Long

Pump Dimensions

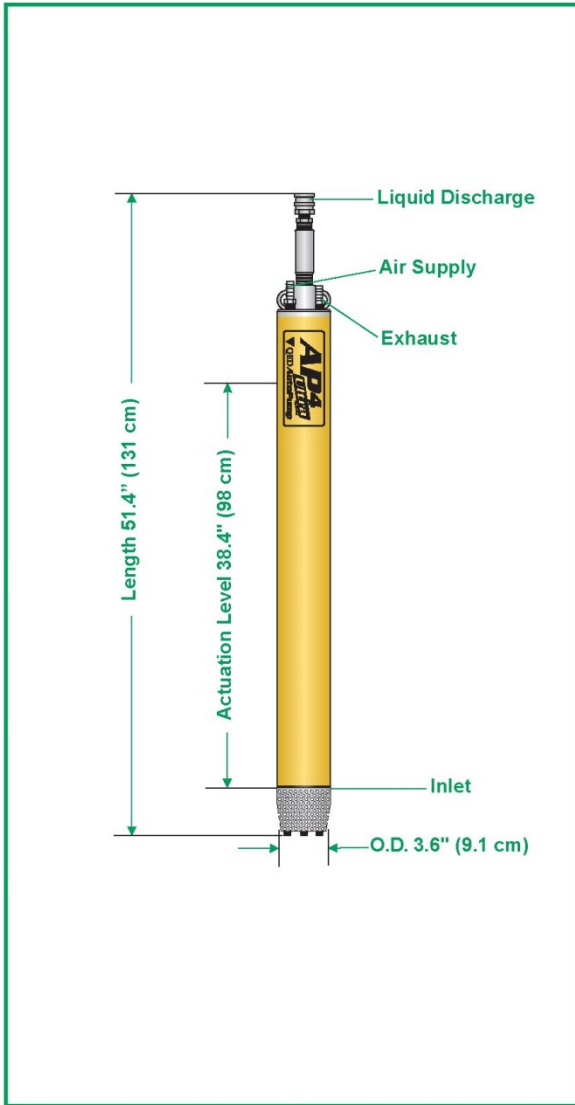

Specifications & Operating Requirements

Model	4" - Long AP4.0 Bottom Inlet
Liquid Inlet Location	Bottom
OD	3.6 in. (9.1 cm)
Length Overall (pump & fittings)	51.4 in. (131 cm)
Weight	16 lbs. (7.3 kg)
Max. Flow Rate	14 gpm (53 lpm) - See Flow Rate Chart ¹
Pump Volume / Cycle	0.58 - 0.78 gal (2.2 - 3.0L)
Min. Actuation Level	38.4 in. (98 cm)
Standard Pump	
Max. Depth	250 ft. (76 m)
Air Pressure Range	5 - 120 psi (0.4 - 8.4 kg/cm ²)
Air Usage	0.4-1.1 scf / gal. (3.0-8.5 liters of air / fluid liter) - See Air Usage Chart
High Pressure Pump	
Max. Depth	425 ft. (130 m)
Air Pressure Range	5 - 200 psi (0.4 - 14.1 kg/cm ²)
Min. Liquid Density	0.7 SpG (0.7 g/cm ³)
Standard Construction Materials¹	
Pump Body	Fiberglass or Stainless Steel
Pump Ends	316 Stainless Steel
Internal Components	316 Stainless Steel, Viton, PVDF ³
Tube & Hose Fittings	316 Stainless Steel
Fitting Type	Barbs or Quick Connects or Easy Fittings
Tube & Hose Options	
Tubing Material²	Nylon
Sizes - Liquid Discharge	1 in. (25 mm) or 1-1/4 in. (32 mm) OD
Pump Air Supply	1/2 in. (13 mm) OD
Air Exhaust	5/8 in. (16 mm) OD
Hose Material	Nitrile
Sizes - Liquid Discharge	3/4 in. (19 mm) or 1 in. (25 mm) ID
Pump Air Supply	3/8 in. (9.5 mm) ID
Air Exhaust	1/2 in. (13 mm) ID

¹ Material upgrades available ³ PVDF - Polyvinylidene Fluoride ² Applies to QED supplied tubing; other tubing sources may not conform to QED fittings.

Application Limits (Base model)

AutoPump Ultra 4.0 pumps are designed to handle the application ranges described below. For applications outside these ranges, consult QED about AP4 upgrades.

Maximum Temperature: Up to 250 °F (121 °C) with certain models
pH Range: 2-12

¹Consult QED for higher flow requirements

¹FLOW RATES MAY VARY WITH SITE CONDITIONS. CALL QED FOR TECHNICAL ASSISTANCE.

AutoPump Ultra 4.0 Long and Short pumps are warranted for five (5) years: 100% materials and workmanship.

¹Consult QED for higher flow requirements

**3/4 inch (19 mm)
Inside Diameter Discharge Hose
(Equivalent to 1-Inch O.D. Tubing)**

**1 inch (25.4 mm)
Inside Diameter Discharge Hose
(Equivalent to 1.25-Inch O.D. Tubing)**

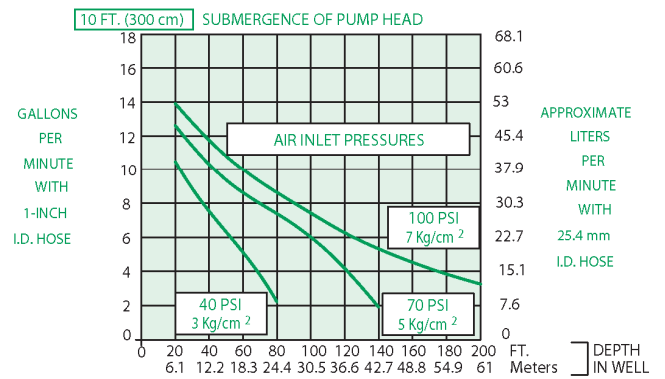
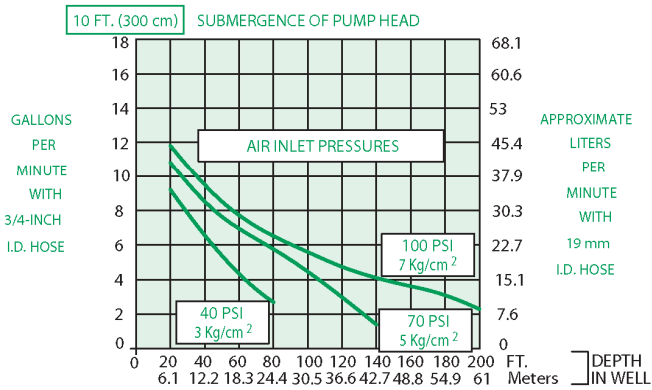
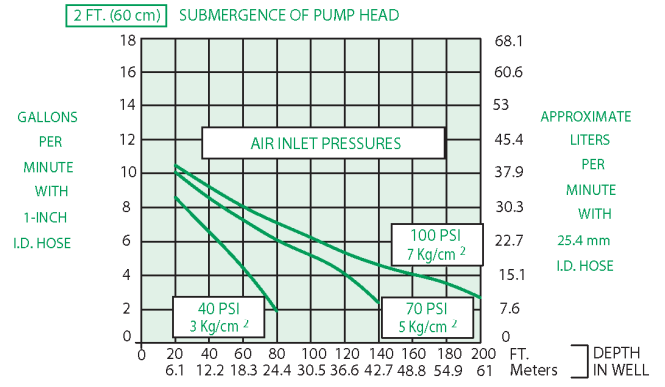
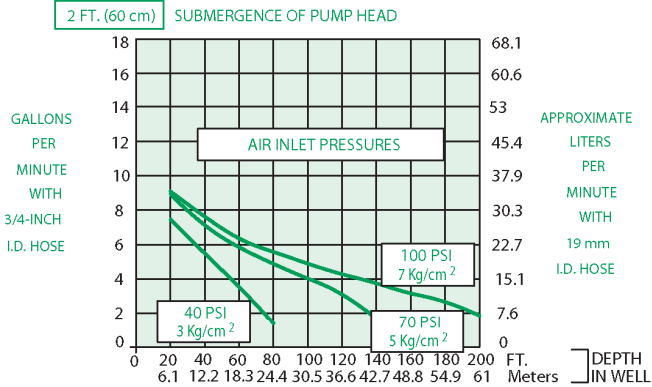
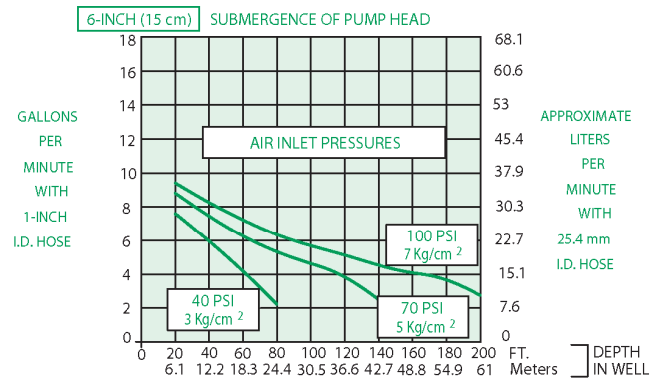
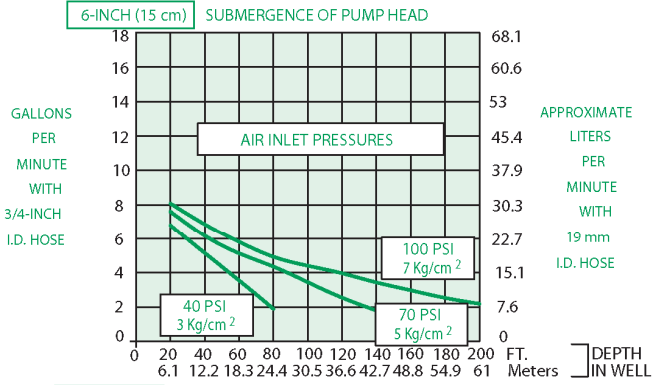

¹FLOW RATES MAY VARY WITH SITE CONDITIONS. CALL QED FOR TECHNICAL ASSISTANCE.

Specifications - Bottom Inlet Long
Bottom Inlet Long

Air Consumption



STANDARD CUBIC FEET OF AIR PER GALLON PUMPED (SCF/GAL)

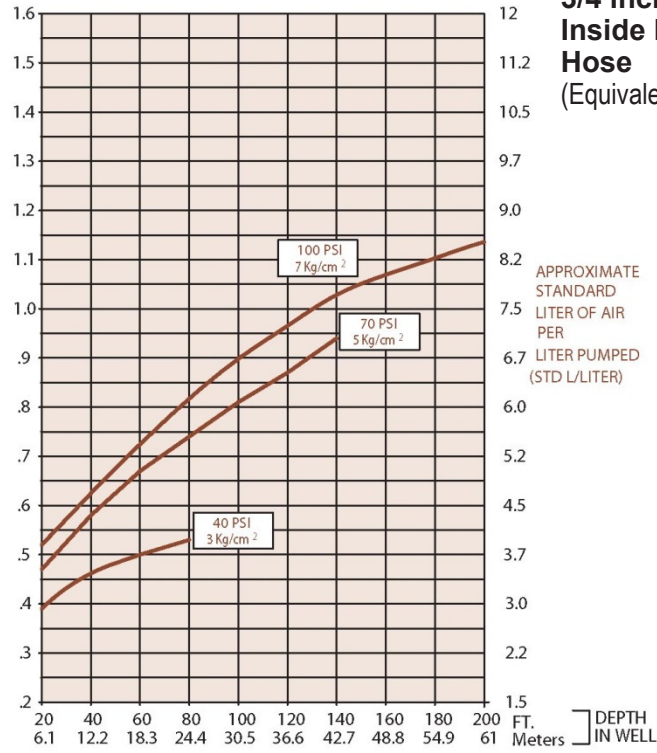

APPROXIMATE STANDARD LITER OF AIR PER LITER PUMPED (STD L/LITER)

STANDARD CUBIC FEET OF AIR PER GALLON PUMPED (SCF/GAL)

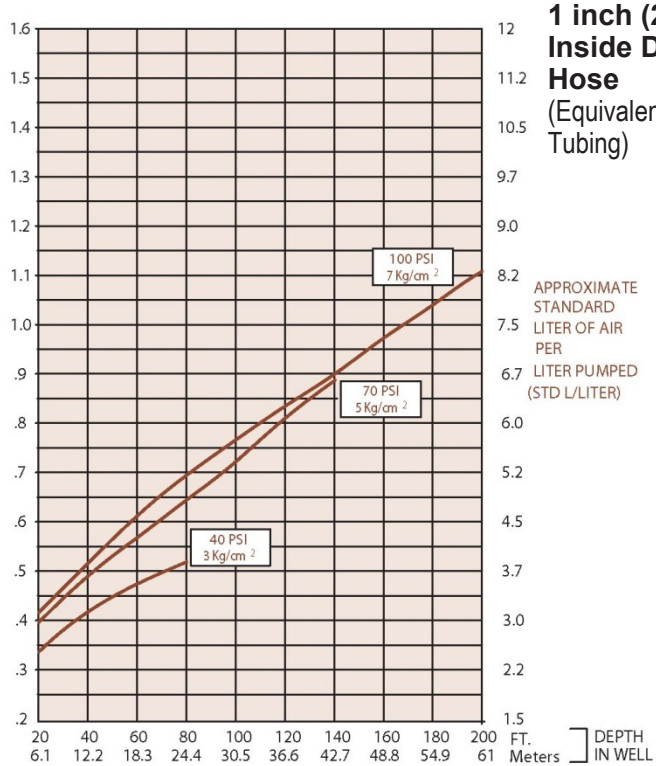

APPROXIMATE STANDARD LITER OF AIR PER LITER PUMPED (STD L/LITER)

Specifications - Bottom Inlet, Short

Bottom Inlet, Short

Max. Flow 13 gpm (49 lpm)
O.D. 3.6 in. (9.1 cm)
Length 39.3 in. (100 cm)



Description

The AutoPump® Ultra 4.0 Bottom Inlet Short provides maximum capabilities and flow in a bottom inlet pump for 4" (100 mm) diameter and larger wells with shorter water columns and/or the need to pump down to lower water levels, compared to full-length pumps, and it can deliver flow rates up to 13 gpm (49 lpm)².

The Ultra 4.0 uses proprietary non-stick finishes on the float and discharge tube to reduce solids buildup, extending the time between cleaning and making it much faster and easier to clean the pump. All metallic parts are 316-grade Stainless Steel, which has greater corrosion resistance and can withstand attacks of the harshest leachate. The AP4.0 Bottom Inlet Short pump is complemented by the most comprehensive selection of accessories to provide a complete system to meet site-specific requirements. Call QED for prompt, no-obligation assistance on your pumping project needs.

The AutoPump Heritage

The AutoPump Ultra 4.0 Bottom Inlet Short is part of the famous AutoPump family of original automatic air-powered pumps, developed in the mid 1980s specifically to handle unique pumping needs at remediation and landfill sites.

Over the years they've proven their durability at thousands of sites worldwide. AutoPumps are designed to handle difficult pumping challenges that other pumps can't, such as hydrocarbons, solvents, suspended solids, corrosives, temperature extremes, viscous fluids and frequent start/ stop cycles. Beyond just the pump, AutoPump systems offer the most complete range of tubing, hose, connectors, wellhead caps and accessories to help your installation go smoothly. This superior pumping heritage, application experience and support back up every AutoPump you put to work on your project.

Advantages

1. **The original automatic air-powered well pump, proven worldwide over 30 years.**
2. **Proprietary finishes extend the time between cleaning.**
3. **All metallic parts are 316-grade SS for better corrosion resistance.**
4. **New and improved valve stem connections have no fasteners, or cotter pins. Exhaust seat is easy to adjust.**
5. **Temperature ratings up to 250 °F, making it ideal for high temperature applications.**
6. **Five-year warranty.**

²Consult QED for higher flow requirements

Specifications - **Bottom Inlet, Short**

Pump Dimensions

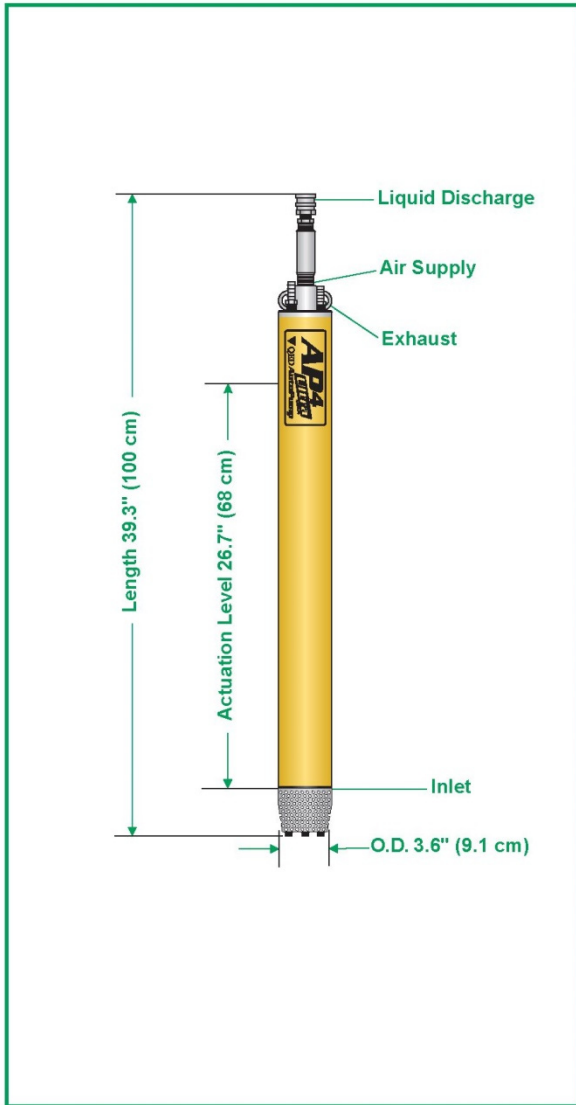

Specifications & Operating Requirements

Model	4" - Short AP4.0 Bottom Inlet
Liquid Inlet Location	Bottom
OD	3.6 in. (9.1 cm)
Length Overall (pump & fittings)	39.3 in. (100 cm)
Weight	13 lbs. (5.9 kg)
Max. Flow Rate	13 gpm (49 lpm) ³ - See Flow Rate Chart
Pump Volume / Cycle	0.22 - 0.36 gal (.83 - 1.36L)
Min. Actuation Level	26.7 in. (68 cm)
Standard Pump	
Max. Depth	250 ft. (76 m)
Air Pressure Range	5 - 120 psi (0.4 - 8.4 kg/cm ²)
Air Usage	0.4-1.5 scf / gal. (1.5 - 5.7 liters of air / fluid liter) - See Air Usage Chart
High Pressure Pump	
Max. Depth	425 ft. (130 m)
Air Pressure Range	5 - 200 psi (0.4 - 14.1 kg/cm ²)
Min. Liquid Density	0.7 SpG (0.7 g/cm ³)
Standard Construction Materials	
Pump Body	Fiberglass or Stainless Steel
Pump Ends	316 Stainless Steel
Internal Components	316 Stainless Steel, Viton, PVDF ³
Tube & Hose Fittings	316 Stainless Steel
Fitting Type	Barbs or Quick Connects or Easy Fittings
Tube & Hose Options	
Tubing Material²	Nylon
Sizes - Liquid Discharge	1 in. (25 mm) or 1-1/4 in. (32 mm) OD
Pump Air Supply	1/2 in. (13 mm) OD
Air Exhaust	5/8 in. (16 mm) OD
Hose Material	Nitrile
Sizes - Liquid Discharge	3/4 in. (19 mm) or 1 in. (25 mm) ID
Pump Air Supply	3/8 in. (9.5 mm) ID
Air Exhaust	1/2 in. (13 mm) ID

² Applies to QED supplied tubing; ³PVDF - Polyvinylidene Fluoride
other tubing sources may not conform to QED fittings.

Application Limits (Base model)

AutoPump Ultra 4.0 pumps are designed to handle the application ranges described below. For applications outside these ranges, consult QED about AP4 upgrades.

Maximum Temperature: Up to 250 °F (121 °C) with certain models
pH Range: 2-12

*Consult QED for higher flow requirements

AutoPump Ultra 4.0 Long and Short pumps are warranted for five (5) years: 100% materials and workmanship.

Bottom Inlet, Short

Flow Rates⁴

**3/4 inch (19 mm)
Inside Diameter Discharge Hose**

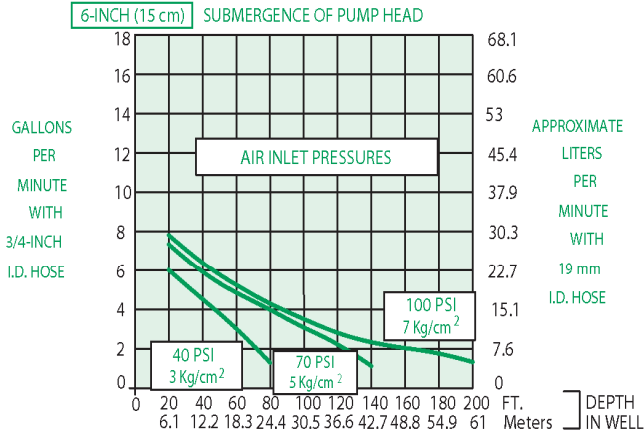

**1 inch (25.4 mm)
Inside Diameter Discharge Hose
(Equivalent to 1.25-Inch O.D. Tubing)**

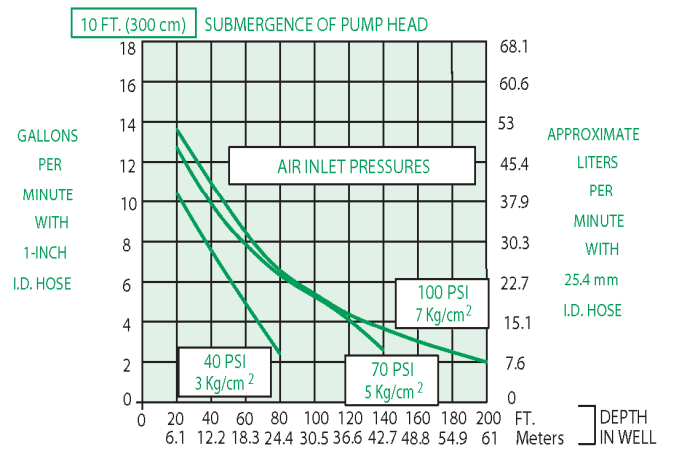
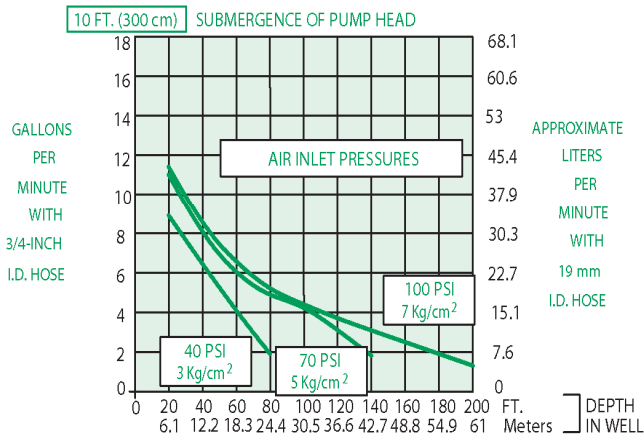
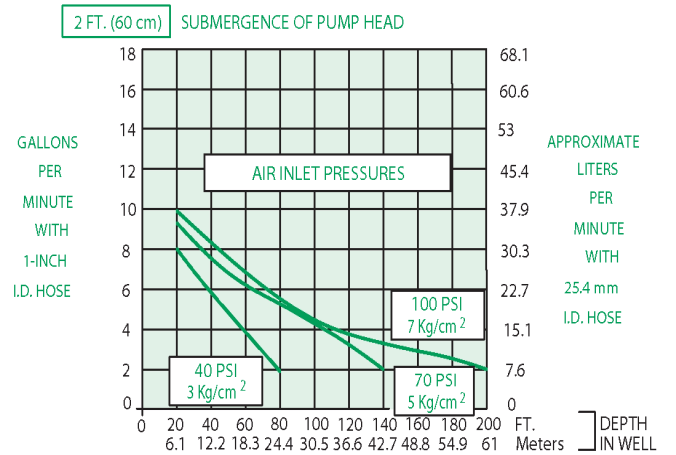
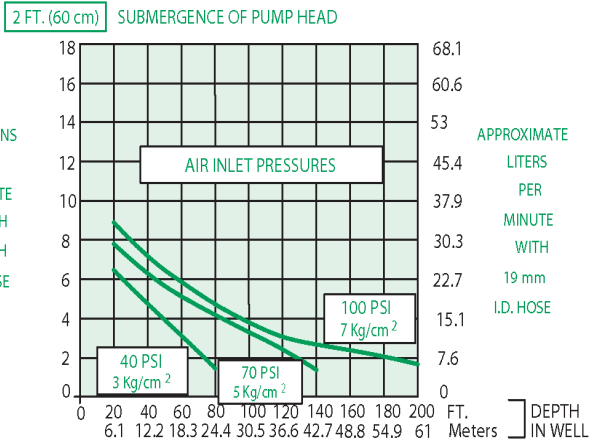
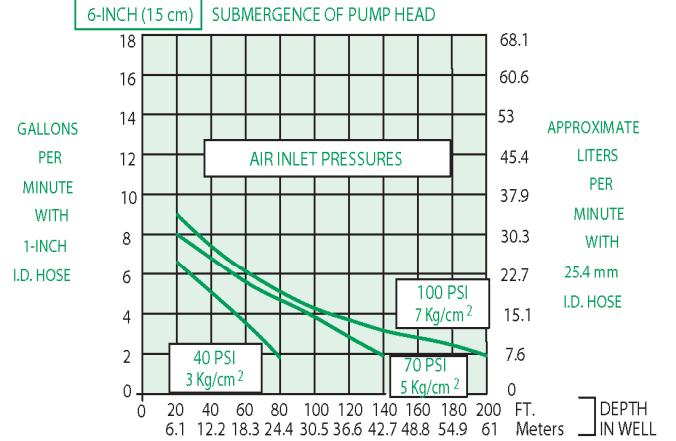

⁴FLOW RATES MAY VARY WITH SITE CONDITIONS. CALL QED FOR TECHNICAL ASSISTANCE.

Bottom Inlet, Short

Air Consumption



STANDARD CUBIC FEET OF AIR PER GALLON PUMPED (SCF/GAL)

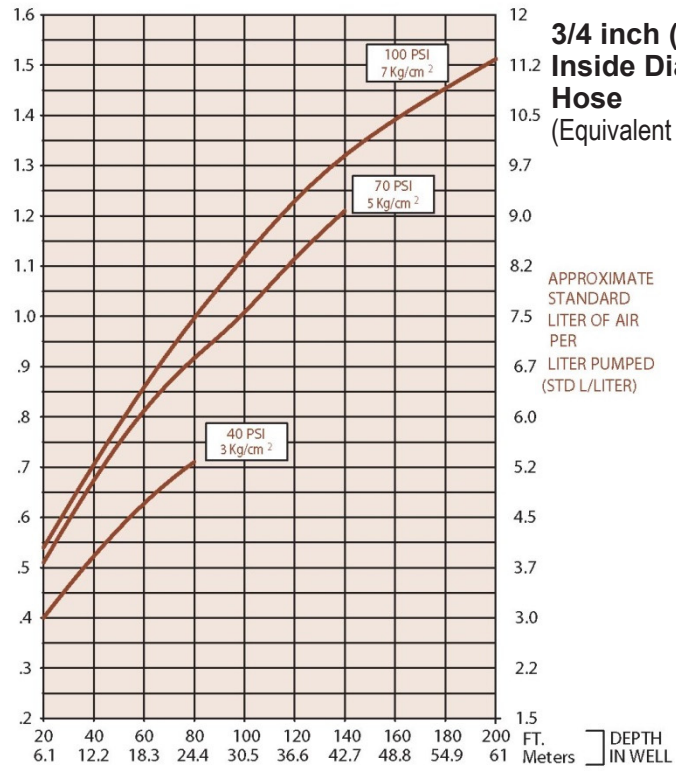

3/4 inch (19 mm) Inside Diameter Discharge Hose
(Equivalent to 1-Inch O.D. Tubing)

APPROXIMATE STANDARD LITER OF AIR PER LITER PUMPED (STD L/LITER)

STANDARD CUBIC FEET OF AIR PER GALLON PUMPED (SCF/GAL)

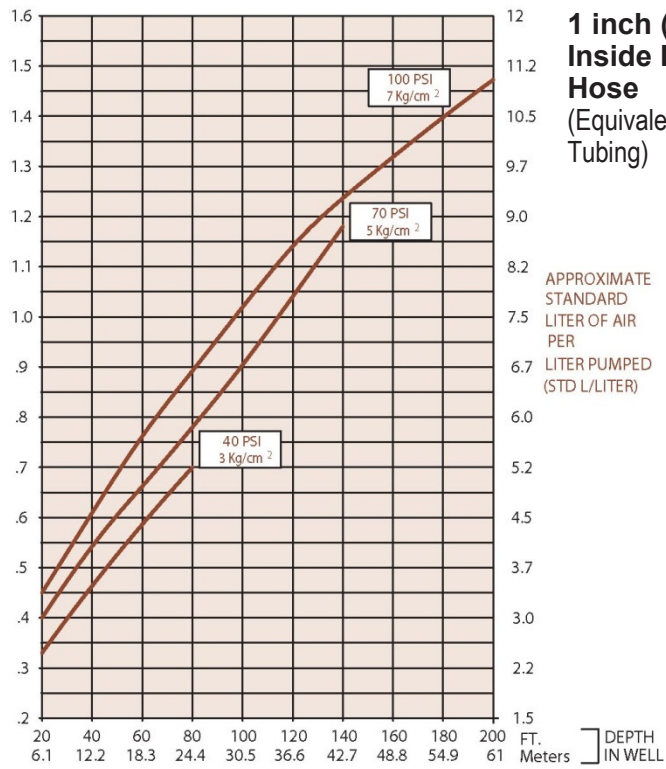

1 inch (25.4 mm) Inside Diameter Discharge Hose
(Equivalent to 1.25-Inch O.D. Tubing)

APPROXIMATE STANDARD LITER OF AIR PER LITER PUMPED (STD L/LITER)

Top Inlet, Long

Max. Flow 10 gpm (38 lpm)
O.D. 3.6 in. (9.1 cm)
Length 56.7 in. (144 cm)



Description

The AutoPump® Ultra 4.0 Top Inlet Long provides maximum capabilities and flow in a top inlet pump for 4" diameter and larger wells needing an elevated inlet, such as pumping total fluids from wells contaminated with LNAPLs, and it can deliver flow rates up to 10 gpm (38 lpm)5. The Ultra 4.0 uses proprietary non-stick finishes on the float and discharge tube to reduce solids buildup, extending the time between cleaning and making it much faster and easier to clean the pump. All metallic parts are 316-grade Stainless Steel, which has greater corrosion resistance and can withstand attacks of the harshest leachate. The AP4.0 Top Inlet Long pump is complemented by the most comprehensive selection of accessories to provide a complete system to meet site-specific requirements. Call QED for prompt, no-obligation assistance on your pumping project needs.

The AutoPump Heritage

The AutoPump Ultra 4.0 Top Inlet Long is part of the famous AutoPump family of original automatic air-powered pumps, developed in the mid 1980s specifically to handle unique pumping needs at remediation and landfill sites. Over the years they've proven their durability at thousands of sites worldwide. AutoPumps are designed to handle difficult pumping challenges that other pumps can't, such as hydrocarbons, solvents, suspended solids, corrosives, temperature extremes, viscous fluids and frequent start/stop cycles. Beyond just the pump, AutoPump systems offer the most complete range of tubing, hose, connectors, wellhead caps and accessories to help your installation go smoothly. This superior pumping heritage, application experience and support back up every AutoPump you put to work on your project.

Advantages

1. **The original automatic air-powered well pump, proven worldwide over 30 years.**
2. **Proprietary finishes extend the time between cleaning.**
3. **All metallic parts are 316-grade SS for better corrosion resistance.**
4. **New and improved valve stem connections have no fasteners, or cotter pins. Exhaust seat is easy to adjust.**
5. **Temperature ratings up to 250 °F, making it ideal for high temperature applications.**
6. **Five-year warranty.**

*Consult QED for higher flow requirements

Specifications - Top Inlet, Long

Pump Dimensions

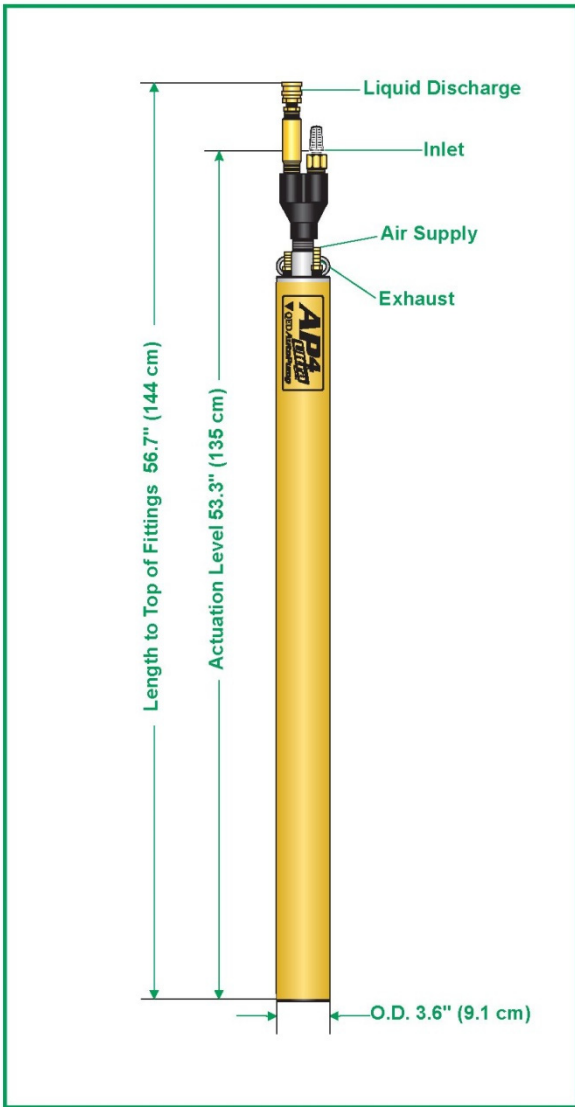

Standard Application Limits (standard model)

AutoPump Ultra 4.0 pumps are designed to handle the application ranges described below.

For applications outside these ranges, consult QED.

Maximum Temperature: Up to 250 °F (121 °C) with certain models
pH Range: 2-12

Specifications & Operating Requirements

Model	4" - Long AP4.0 Top Inlet
Liquid Inlet Location	Top
OD	3.6 in. (9.1 cm)
Length Overall (pump & fittings)	56.7 in. (144 cm)
Weight	18 lbs. (8.7 kg)
Max. Flow Rate	10 gpm (38 lpm) - See Flow Rate Chart
Pump Volume / Cycle	0.58 - 0.78 gal (2.2 - 3.0L)
Min. Actuation Level	53.3 in. (135 cm)
Standard Pump	
Max. Depth	250 ft. (76 m)
Air Pressure Range	5 - 120 psi (0.4 - 8.4 kg/cm ²)
Air Usage	0.35-1.1 scf / gal. (3.0-8.4 liters of air / fluid liter)
High Pressure Pump	
Max. Depth	425 ft. (130 m)
Air Pressure Range	5 - 200 psi (0.4 - 14.1 kg/cm ²)
Min. Liquid Density	0.7 SpG (0.7 g/cm ³)
Standard Construction Materials¹	
Pump Body	Fiberglass or Stainless Steel
Pump Ends	316 Stainless Steel, Acetal
Internal Components	316 Stainless Steel, Viton, Acetal, P ³ VDF
Tube & Hose Fittings	316 Stainless Steel
Fitting Type	Barbs or Quick Connects or Easy Fittings
Tube & Hose Options	
Tubing Material²	Nylon
Sizes - Liquid Discharge	1 in. (25 mm) or 1-1/4 in. (32 mm) OD
Pump Air Supply	1/2 in. (13 mm) OD
Air Exhaust	5/8 in. (16 mm) OD
Hose Material	Nitrile
Sizes - Liquid Discharge	3/4 in. (19 mm) or 1 in. (25 mm) ID
Pump Air Supply	3/8 in. (9.5 mm) ID
Air Exhaust	1/2 in. (13 mm) ID

¹ Material upgrades available ³ PVDF - Polyvinylidene Fluoride ² Applies to QED supplied tubing; other tubing sources may not conform to QED fittings.

AutoPump Ultra 4.0 Long and Short pumps are warranted for five (5) years: 100% materials and workmanship.

Specifications - Top Inlet, Long
Flow Rates¹

**3/4 inch (19 mm)
Inside Diameter Discharge
Hose**
(Equivalent to 1-Inch O.D. Tubing)

**1 inch (25.4 mm)
Inside Diameter Discharge
Hose**
(Equivalent to 1.25-Inch O.D. Tubing)

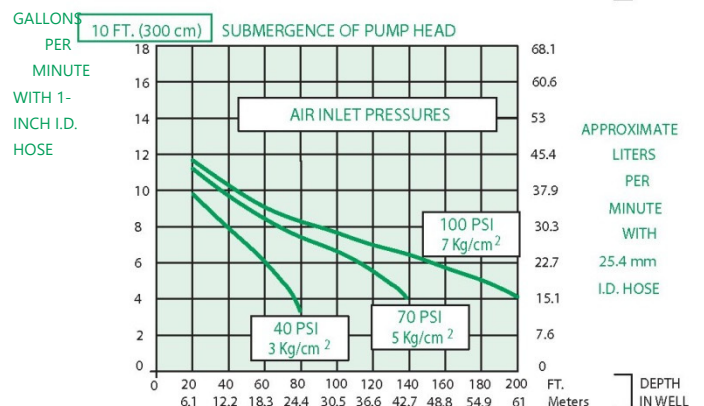
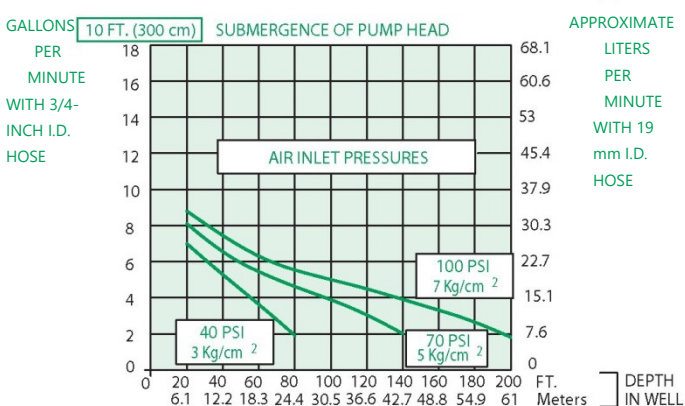
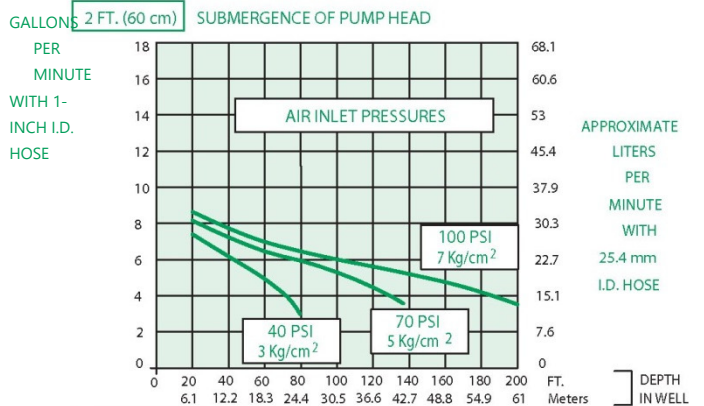
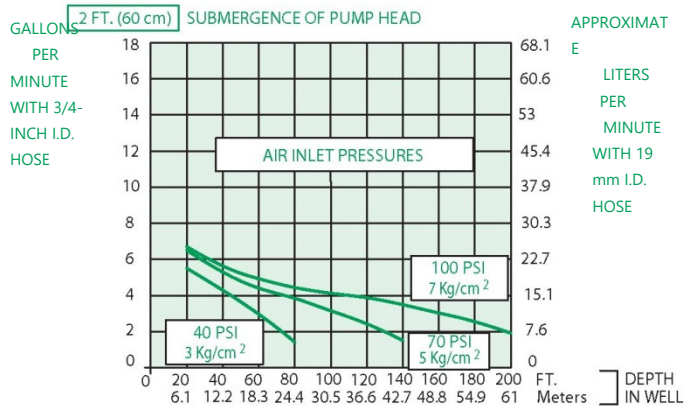
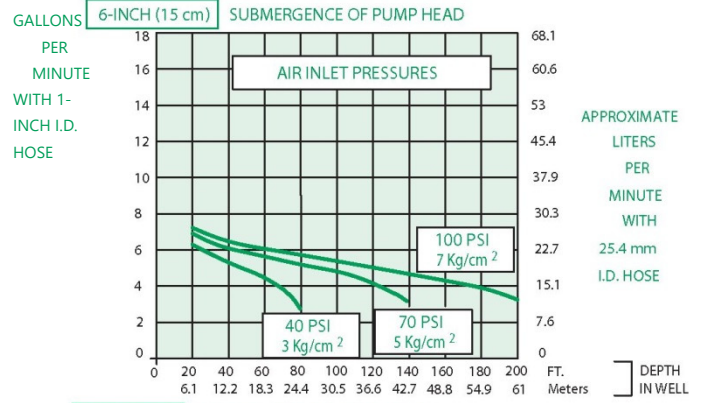
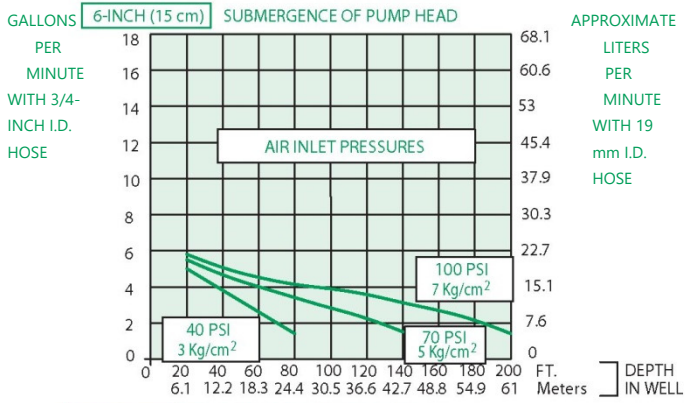

¹FLOW RATES MAY VARY WITH SITE CONDITIONS. CALL QED FOR TECHNICAL ASSISTANCE.

Specifications - Top Inlet, Long

Air Consumption



STANDARD CUBIC FEET OF AIR PER GALLON PUMPED (SCF/GAL)

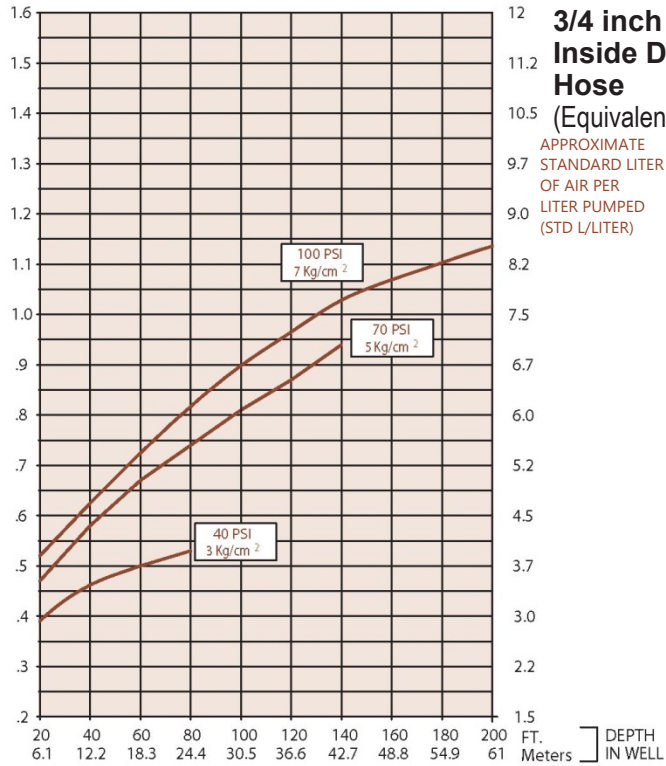

STANDARD CUBIC FEET OF AIR PER GALLON PUMPED (SCF/GAL)

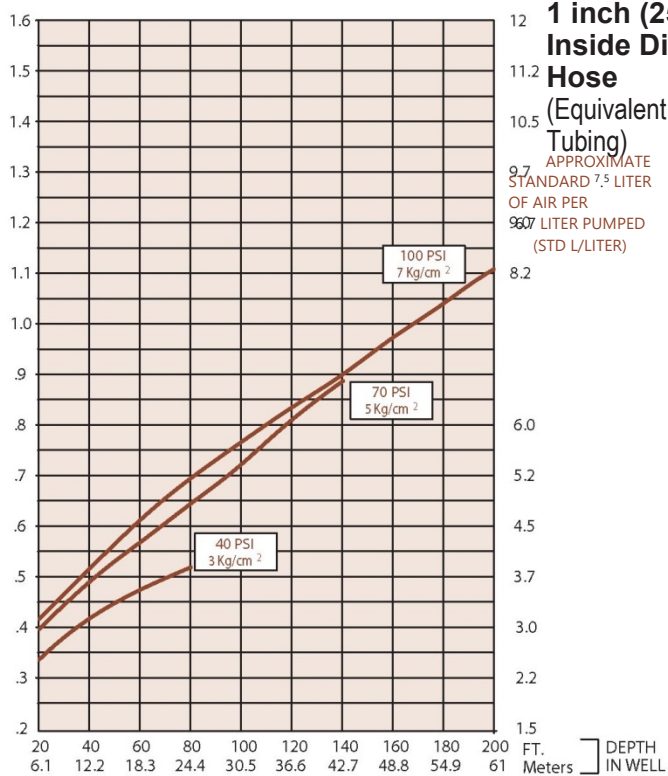

Specifications - Top Inlet, Short

Max. Flow 9 gpm (34 lpm)

O.D. 3.6 in. (9.1 cm)

Length 45 in. (110 cm)

Advantages

1. The original automatic air-powered well pump, proven worldwide over 30 years.
2. Proprietary finishes extend the time between cleaning.
3. All metallic parts are 316-grade SS for better corrosion resistance.
4. New and improved valve stem connections have no fasteners, or cotter pins. Exhaust seat is easy to adjust.
5. Temperature ratings up to 250 °F, making it ideal for high temperature applications.
6. Five-year warranty.



Description

The AutoPump Ultra 4.0 Top Inlet Short provides maximum capabilities and flow in a top inlet pump for 4" (100 mm) diameter and larger wells with shorter water columns and the need for an elevated inlet, such as pumping total fluids from wells contaminated with LNAPLs, and it can deliver flow rates up to 9 gpm (34 lpm). The Ultra 4.0 uses proprietary non-stick finishes on the float and discharge tube to reduce solids buildup, extending the time between cleaning and making it much faster and easier to clean the pump. All metallic parts are 316-grade Stainless Steel, which has greater corrosion resistance and can withstand attacks of the harshest leachate. The AP4.0 Top Inlet Short pump is complemented by the most comprehensive selection of accessories to provide a complete system to meet site-specific requirements. Call QED for prompt, no-obligation assistance on your pumping project needs.

The AutoPump Heritage

The AutoPump Ultra 4.0 Top Inlet Short is part of the famous AutoPump family of original automatic air-powered pumps, developed in the mid 1980s specifically to handle unique pumping needs at remediation and landfill sites. Over the years they've proven their durability at thousands of sites worldwide. AutoPumps are designed to handle difficult pumping challenges that other pumps can't, such as hydrocarbons, solvents, suspended solids, corrosives, temperature extremes, viscous fluids and frequent start/ stop cycles. Beyond just the pump, AutoPump systems offer the most complete range of tubing, hose, connectors, wellhead caps and accessories to help your installation go smoothly. This superior pumping heritage, application experience and support back up every AutoPump you put to work on your project.

*Consult QED for higher flow requirements

Specifications - Top Inlet, Short

Pump Dimensions

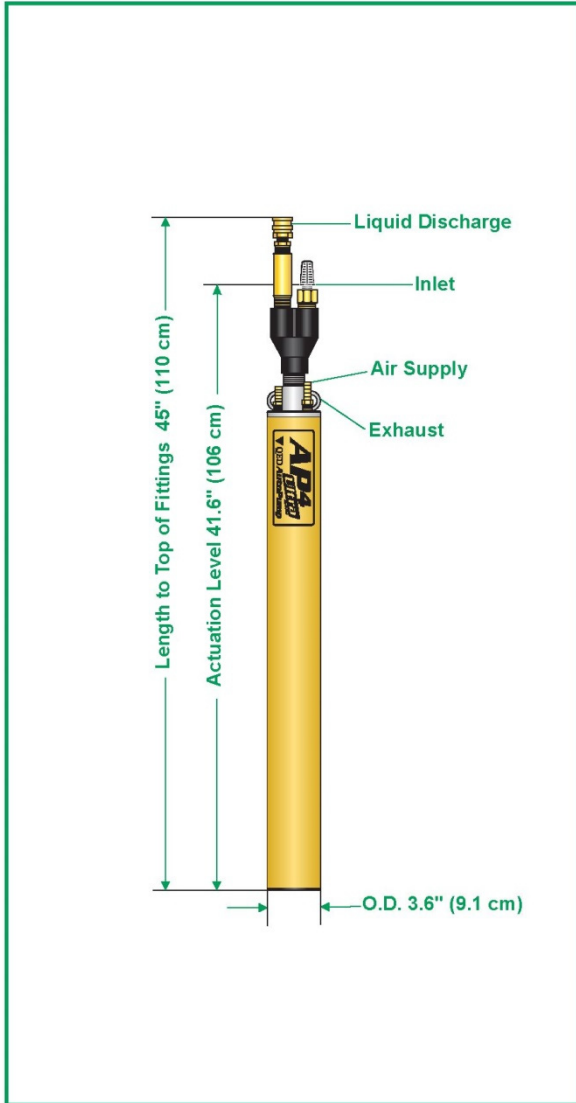

supplied tubing; other tubing sources may not conform to QED fittings.

Specifications & Operating Requirements

Model	4" - Short AP4.0 Top Inlet
Liquid Inlet Location	Top
OD	3.6 in. (9.1 cm)
Length Overall (pump & fittings)	45 in. (110 cm)
Weight	17 lbs. (7.8 kg)
Max. Flow Rate	9 gpm (34 lpm) - See Flow Rate Chart
Pump Volume / Cycle	0.22 - 0.36 gal (.83 - 1.36L)
Min. Actuation Level	41.6 in. (106 cm)
Standard Pump	
Max. Depth	250 ft. (76 m)
Air Pressure Range	5 - 120 psi (0.4 - 8.4 kg/cm ²)
Air Usage	0.35-1.5 scf / gal. (2.4-11.3 liters of air / fluid liter) - See Air Usage Chart
High Pressure Pump	
Max. Depth	425 ft. (130 m)
Air Pressure Range	5 - 200 psi (0.4 - 14.1 kg/cm ²)
Min. Liquid Density	0.7 SpG (0.7 g/cm ³)
Standard Construction Materials¹	
Pump Body	Fiberglass or Stainless Steel
Pump Ends	316 Stainless Steel
Internal Components	316 Stainless Steel, Viton, Acetal, PVDF
Tube & Hose Fittings	316 Stainless Steel
Fitting Type	Barbs or Quick Connects or Easy Fittings
Tube & Hose Options	
Tubing Material²	Nylon
Sizes - Liquid Discharge	1 in. (25 mm) or 1-1/4 in. (32 mm) OD
Pump Air Supply	1/2 in. (13 mm) OD
Air Exhaust	5/8 in. (16 mm) OD
Hose Material	Nitrile
Sizes - Liquid Discharge	3/4 in. (19 mm) or 1 in. (25 mm) ID
Pump Air Supply	3/8 in. (9.5 mm) ID
Air Exhaust	1/2 in. (13 mm) ID

¹ Material upgrades available ³ PVDF - Polyvinylidene Fluoride ² Applies to QED

AutoPump Ultra 4.0 Long and Short pumps are warranted for five (5) years: 100% materials and workmanship.

Standard Application Limits (standard model)

AutoPump Ultra 4.0 pumps are designed to handle the application ranges described below. For applications outside these ranges, consult QED.

Maximum Temperature: Up to 250 °F (121 °C) with certain models pH Range: 2-12

Specifications - Top Inlet, Short

Flow Rates¹

**3/4 inch (19 mm)
Inside Diameter Discharge
Hose**
(Equivalent to 1-Inch O.D. Tubing)

**1 inch (25.4 mm)
Inside Diameter Discharge
Hose**
(Equivalent to 1.25-Inch O.D. Tubing)

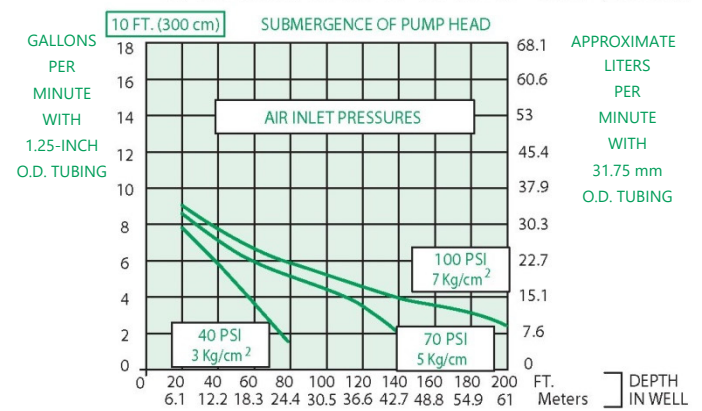
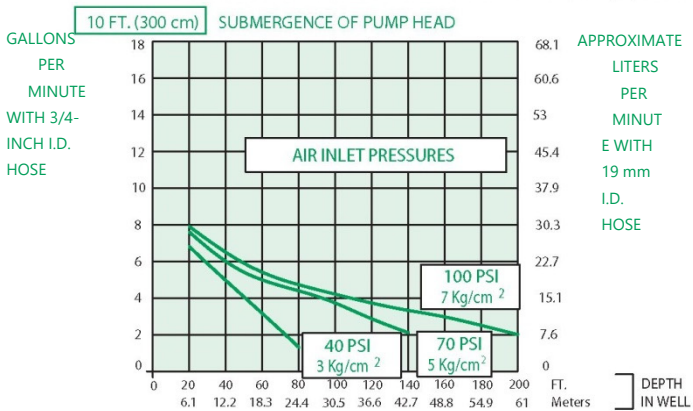
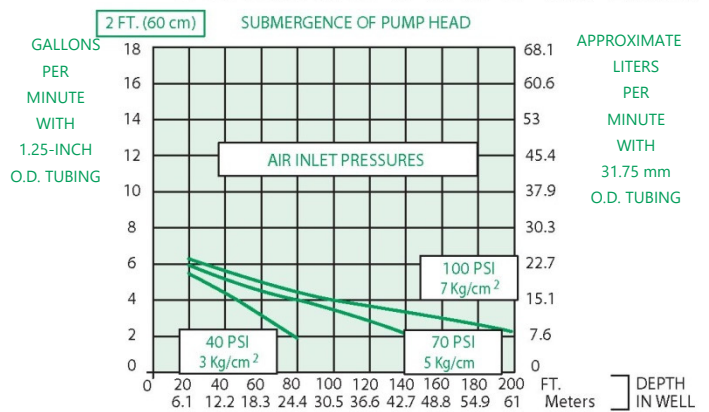
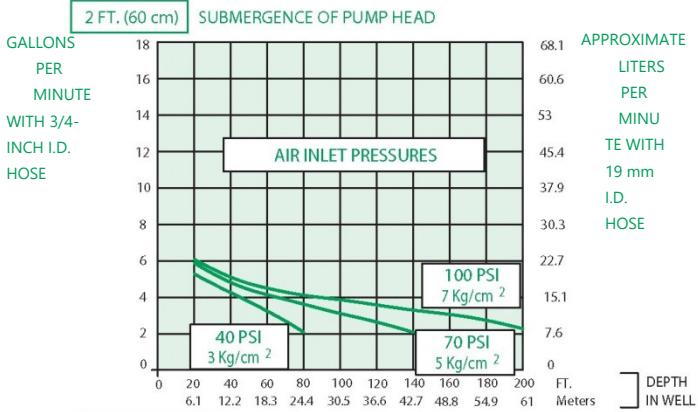
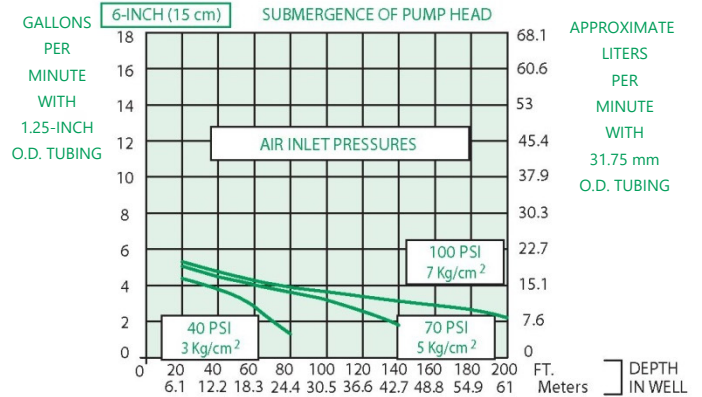
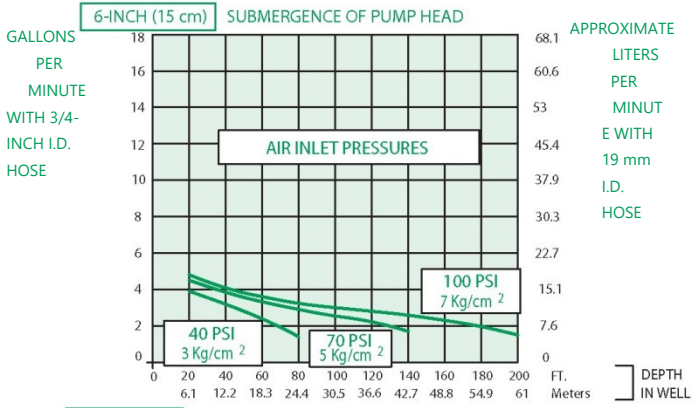

¹FLOW RATES MAY VARY WITH SITE CONDITIONS. CALL QED FOR TECHNICAL ASSISTANCE.

Top Inlet, Short

Air Consumption



STANDARD CUBIC FEET OF AIR PER GALLON PUMPED (SCF/GAL)

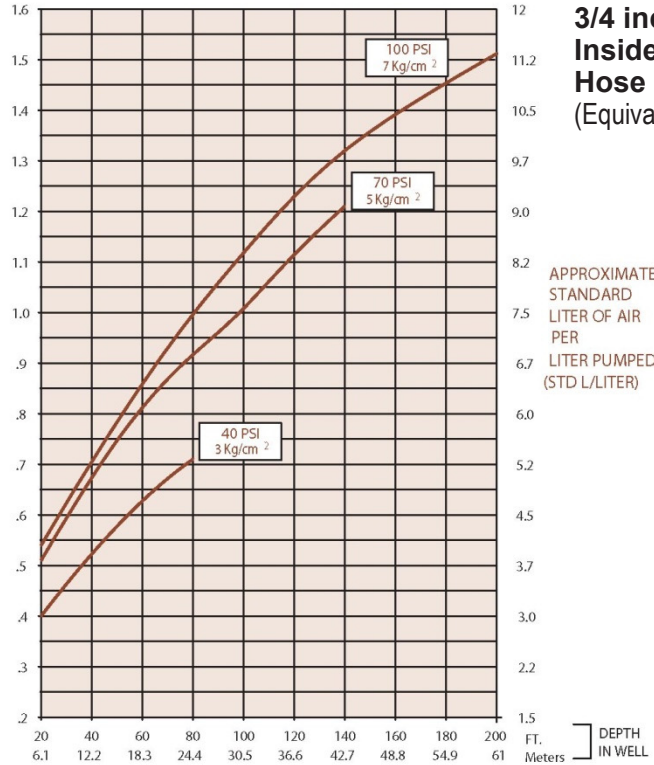

**3/4 inch (19 mm)
Inside Diameter Discharge
Hose**
(Equivalent to 1-Inch O.D. Tubing)

APPROXIMATE
STANDARD
LITER OF AIR
PER
LITER PUMPED
(STD L/LITER)

STANDARD CUBIC FEET OF AIR PER GALLON PUMPED (SCF/GAL)

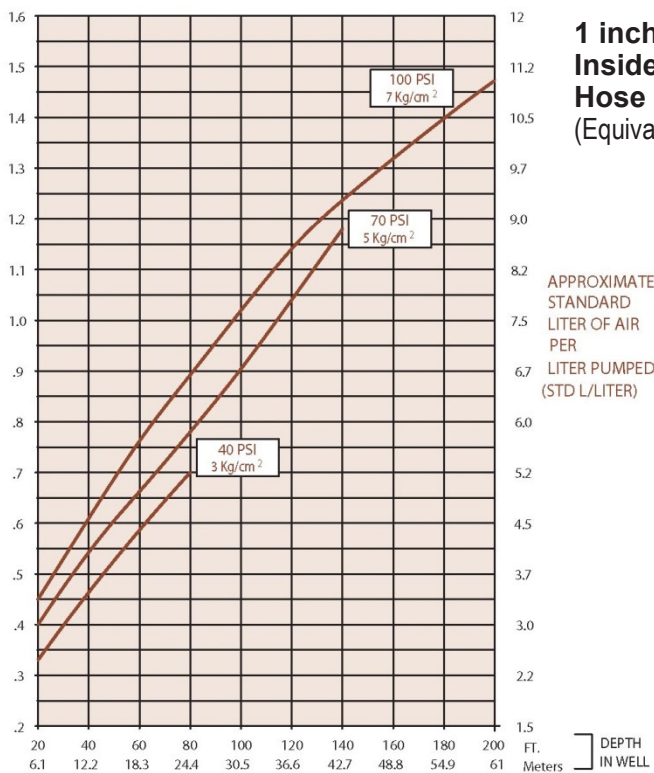

**1 inch (25.4 mm)
Inside Diameter Discharge
Hose**
(Equivalent to 1.25-Inch O.D. Tubing)

APPROXIMATE
STANDARD
LITER OF AIR
PER
LITER PUMPED
(STD L/LITER)

BOTTOM-INLET 4.5 ULTRA 180°F MAX

Standard
4.5" Pump

High Pressure
4.5" Pump

Model	Short AP4.5	Short AP4.5 Ultra
Fluid Inlet	Bottom	Bottom
Diameter	4.562 in. (115.88 mm) O.D.	4.562 in. (115.88 mm) O.D.
Weight	17.8 lbs. (8.074 kg)	17.8 lbs. (8.074 kg)
Length	39.3 in. (101.1 cm)	39.3 in. (101.1 cm)
Vol/Cyc	0.45 - 0.55 gal (1.70 - 2.08 L)	0.45 - 0.55 gal (1.70 - 2.08 L)
Act. Level	26.7 in. (68 cm)	26.7 in. (68 cm)
Max. Flow	13 gpm (49 Lpm)	13 gpm (49 Lpm)
Max. Depth	250 ft. (76 m)	380 ft. (116 m)
Air Press.	5 - 120 psi (0.4 - 8.4 kg/cm ²)	5 - 180 psi (0.4 - 12.655 kg/cm ²)
Air Usage	0.4 - 1.1 scf / gal. (3.0 - 8.5 liter of air / fluid liter)	0.4 - 1.1 scf / gal. (3.0 - 8.5 liter of air / fluid liter)
Min. Liquid Density	+0.7 SpG (0.7 g/cm ³)	+0.7 SpG (0.7 g/cm ³)

Standard Construction Materials¹

Pump Body Fiberglass
 Pump Ends 316 Stainless Steel
 Internal Components 316 S SSI, Viton, PVDF, Hastelloy-C
 Tube & Hose Fittings 316 Stainless Steel
 Fitting Type Barbs, Quick Connects or Easy Fittings

Tube & Hose Options

Tubing Materials Nylon
 Sizes - Liquid Discharge 1 in. (25 mm) or 1-1/4 in. (32 mm)
 Pump Air Supply 1/2 in. (13 mm) OD
 Air Exhaust 5/8 in. (16 mm) OD

Hose Material Nitrile

Sizes - Liquid Discharge 3/4 in. (19 mm) or 1 in. (25 mm) ID
 Pump Air Supply 3/8 in. (9.5 mm) ID
 Air Exhaust 1/2 in. (13 mm)

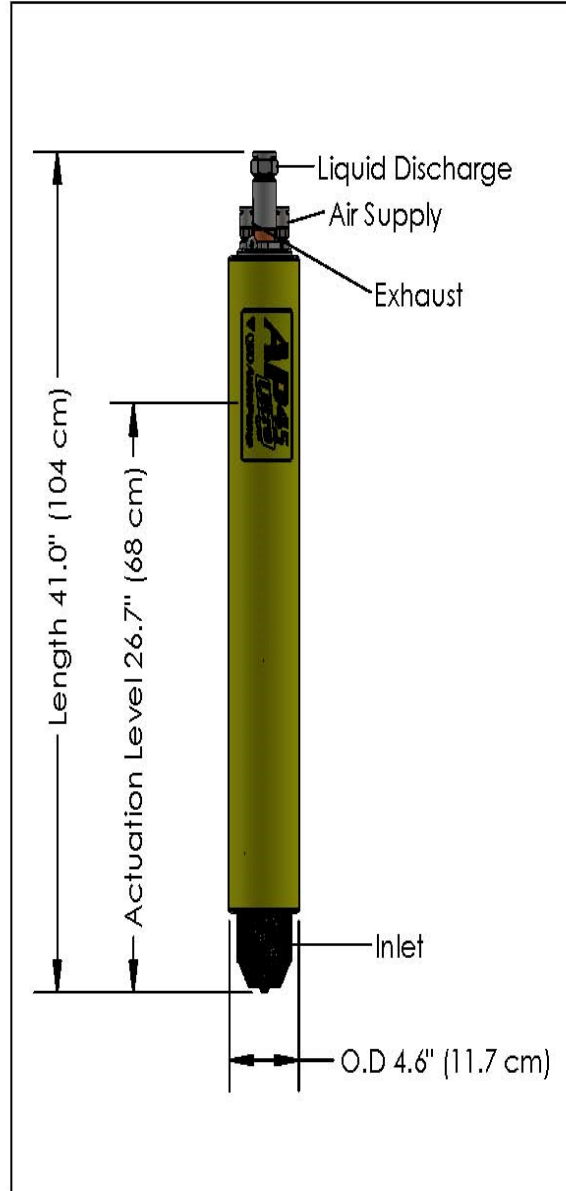

BOTTOM-INLET 4.5 ULTRA 250°F MAX

Standard
4.5" Pump

High Pressure
4.5" Pump

Model	Short AP4.5	Short AP4.5 Ultra
Fluid Inlet	Bottom	Bottom
Diameter	4.562 in. (115.88 mm) O.D.	4.562 in. (115.88 mm) O.D.
Weight	17.8 lbs. (8.074 kg)	17.8 lbs. (8.074 kg)
Length	39.3 in. (101.1 cm)	39.3 in. (101.1 cm)
Vol/Cyc	0.45 - 0.55 gal (1.70 - 2.08 L)	0.45 - 0.55 gal (1.70 - 2.08 L)
Act. Level	26.7 in. (68 cm)	26.7 in. (68 cm)
Max. Flow	13 gpm (49 Lpm)	13 gpm (49 Lpm)
Max. Depth	250 ft. (76 m)	380 ft. (116 m)
Air Press.	5 - 120 psi (0.4 - 8.4 kg/cm ²)	5 - 180 psi (0.4 - 12.655 kg/cm ²)
Air Usage	0.4 - 1.1 scf / gal. (3.0 - 8.5 liter of air /fluid liter)	0.4 - 1.1 scf / gal. (3.0 - 8.5 liter of air /fluid liter)
Min. Liquid Density	+0.7 SpG (0.7 g/cm ³)	+0.7 SpG (0.7 g/cm ³)

Standard Construction Materials¹

Pump Body 316 Stainless Steel
 Pump Ends 316 Stainless Steel
 Internal Components 316 S, Viton, PVDF, Hastelloy-C
 Tube & Hose Fittings 316 Stainless Steel
 Fitting Type Barbs, Quick Connects or Easy Fittings

Tube & Hose Options

Tubing Materials Nylon
 Sizes - Liquid Discharge 1 in. (25 mm) or 1-1/4 in. (32 mm)
 Pump Air Supply 1/2 in. (13 mm) OD
 Air Exhaust 5/8 in. (16 mm) OD

Hose Material Nitrile

Sizes - Liquid Discharge 3/4 in. (19 mm) or 1 in. (25 mm) ID
 Pump Air Supply 3/8 in. (9.5 mm) ID
 Air Exhaust 1/2 in. (13 mm)

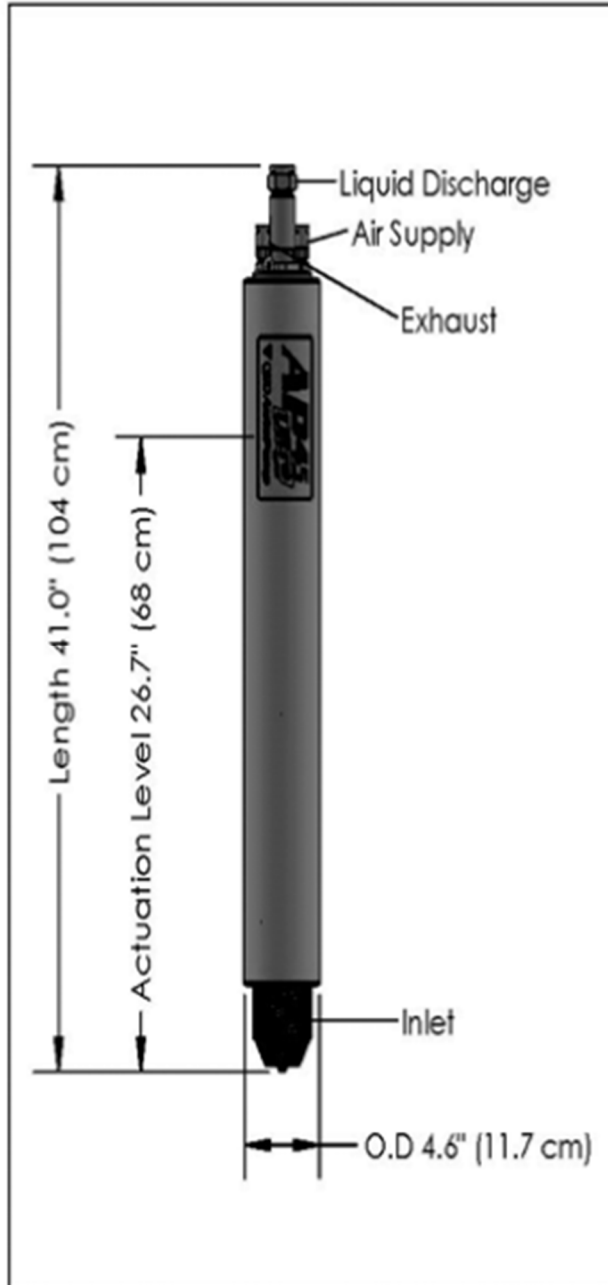

The new AutoPump® AP4.5 Ultra (Patent Pending) delivers superior performance, running many times longer between service events. A pump installed for field testing needed just 30 minutes to clean after 220,000 minutes (348,965 cycles!) of uninterrupted run time – in a well that had been out of compliance for the previous 3 years, requiring pump cleaning every 3 to 5 days.

With a larger diameter and three times the clearance between the float, casing and discharge tube, the AP4.5 Ultra achieves the same flow rate as the standard AP4 with fewer cycles. This results in less wear per gallon pumped, extending equipment life cycle. Greater clearance also enables the pump to deal with high viscosities, solids content and precipitates in the pumped fluid.

Proprietary non-stick finishes combine with the higher-clearance design to reduce solids buildup, increasing the interval between required service events even further. Pump cleaning is much faster and easier, often needing only a water spray and a light wipe. Metallic parts are all 316 grade Stainless Steel, resisting corrosion by the harshest leachates and highest temperatures.

Application Limits

(Base model)

AutoPump Ultra 4.0 and 4.5 pumps are designed to handle the application ranges described below.

For applications outside these ranges, consult QED about AP4 upgrades.

Maximum Temperature: Up to 250 °F (121 °C) with certain models

pH Range: 2-12

*Consult QED for higher flow requirements



Five Year Warranty

This limited warranty is in lieu of and excludes all other representations made by advertisements, distributors, agents, or manufacturers sales representatives, and all other warranties, both express and implied. There are no implied warranties of merchantability or of fitness for a particular purpose for goods covered hereunder.

QED Environmental Systems warrants to the purchaser of its products that, subject to the limitations and conditions provided within the Terms & Conditions of Sale, products, materials and/or workmanship shall reasonably conform to descriptions of the products and shall be free of defects in material and workmanship.

All warranty durations are calculated from the original date of purchase—determined as beginning the date of shipment from QED facilities and the date QED is notified of a warranty claim. This warranty shall be limited to the duration and conditions set forth below.

1. AP4 Ultra Pumps - Warranted for five (5) years: 100% material and 100% workmanship. This limited warranty coverage only applies to long and short AP4 Ultra Pumps purchased with this warranty. There will be no warranty for application or material compatibility. The materials used in pumps vary depending upon application and the customer is responsible for knowing the environment in which the pump will be operating and working with QED to determine what materials of construction will be best for the application.

The warranty is valid when the following conditions exist: when the site has a pH between 2 and 12, has a salinity of 9,000ppm or less, is between 40 and 180 degrees Fahrenheit (250 degrees F for high temperature pumps), is noncorrosive to the construction materials of the pump, and is not abrasive. Typical commercial fuels are acceptable materials in free and dissolved phase. The pumps and accessories must be operated within the specifications and limits given in the manual for the particular piece of equipment.

2. Hose, Tubing, Fittings, And Air Filtration Housings - Warranted for one (1) year: 100% material and 100% workmanship. There will be no warranty for application or material compatibility. The materials used vary depending upon application and the customer is responsible for knowing the environment in which the equipment will be operating and working with QED to determine what materials of construction will be best for the application.

3. Wellheads, Well Caps, Flow Meters, Pneumatic Data Modules - Warranted for one (1) year: 100% material and 100% workmanship.

4. Precision Fine Tune Control Valves - Warranted for two (2) years: 100% material and 100% workmanship.

5. Parts and Repairs - Warranted for ninety (90) days: 100% material and 100% workmanship; when repairs are performed by QED or its appointed agent; from date of repair or for the full term of the original warranty, whichever is longer. Separately sold parts are warranted for ninety (90) days: 100% materials and 100% workmanship.

This warranty will be void in the event of unauthorized disassembly of component assemblies. Defects in any equipment that result from abuse, operation in any manner outside the recommended procedures, use and applications other than for intended use or exposure physical environments beyond the designated limits of materials and construction, will also void the warranty.

Chemical attack by liquids, gases or abrasive substances contacting equipment and accessories shall not be covered by this warranty. A range of materials of construction is available from QED and it is the buyer's responsibility to select materials of construction to fit buyer's application. QED will only warrant that the supplied materials will conform to published QED specifications and generally accepted standards for that particular material.

QED Environmental Systems shall be released from all obligations under all warranties if any product covered hereby is repaired or modified by persons other than QED service personnel (unless such repair by others is made with the written consent of QED); resold to other parties; and/or moved to or used on a site other than originally specified.

It is understood and agreed that QED Environmental Systems shall in no event be liable for incidental or consequential damages resulting from its breach of any of the terms of this agreement, nor for special damages, nor for improper selection of any product described or referred to for a particular application. Liability under this warranty is limited to repair or replacement F.O.B. QED's factory, or its appointed agent's shop, of any parts which prove to be defective within the duration and conditions set forth herein, or repayment of the purchase price at the option of QED, provided the products have been returned in accordance with the duration and conditions set forth herein.

Subassemblies and Other Equipment Manufactured by Others

The foregoing warranty does not apply to major subassemblies and other equipment, accessories, and other parts manufactured by others, and such other parts, accessories, and equipment are subject only to the warranties, if any, supplied by their respective manufacturers. QED makes no warranty concerning products or accessories not manufactured by QED. In the event of failure of any such product or accessory, QED will give reasonable assistance to Buyer in obtaining from the respective manufacturer whatever adjustment is reasonable in light of the manufacturer's own warranty.

Illustrations and Drawings

Reasonable effort has been made to have all illustrations and drawings accurately represent the product(s) as it actually was at the time of doing the illustrations and drawings. However, products may change to meet user requirement and therefore may not be reflected in the literature. In addition, literature may be updated to reflect the most recent equipment revision(s). Changes to either or both equipment and/or literature can be made without notice.

Buyer's Remedies

The buyer's exclusive and sole remedy on account of or in respect to the furnishing of defective material or workmanship shall be to secure replacement thereof as aforesaid. QED shall not in any event be liable for the cost of any labor expended on any such product or material or for any special, direct, indirect or consequential damages to any one by reason of the fact that it shall have been deemed defective or a breach of said warranty.

Changes without Notice

Prices and specifications are subject to change without notice.

Shipping Dates

Shipping dates are approximate and are subject to delays beyond our control.

F.O.B. Point and Title

All material is sold F.O.B. factory. Title to all merchandise sold shall pass to Buyer upon delivery by Seller to carrier at factory. All freight insurance is the responsibility of the Buyer and shall be charged to the Buyer on the invoice unless directed in writing. All Freight claims are the Buyer's responsibility.

Terms

Payment terms are Net 30 days; 1.0% per month past due.

State and Local Taxes

Any taxes, duties or fees which the seller may be required to pay or collect upon or with respect to the sale, purchase, delivery, use or consumption of any of the material covered hereby shall be for the account of the Buyer and shall be added to the purchase price.

Acceptance

All orders shall be subject to the terms and conditions contained or referred to in the Seller's quotation, acknowledgments and to those listed here and to no others whatsoever. No waiver, alteration or modification of these terms and conditions



shall be binding unless in writing and signed by an executive officer of the Seller. All orders subject to written acceptance by QED Environmental Systems, Ann Arbor, MI, U.S.A.

Warranty Claims Procedure (Responsibility of purchaser)

The original purchaser's sole responsibility in the instance of a warranty claim shall be to notify QED or its appointed agent, of the defect, malfunction, or other manner in which the terms of this warranty are believed to be violated. The purchaser may secure performance of obligations hereunder by contacting the Customer Service Department of QED or its appointed agent, and:

1. Identifying the product involved by model or serial number, or other sufficient description, that will allow QED, or its appointed agent, to determine which product is defective.
2. Specifying where, when, and from whom the product was purchased.
3. Describing the nature of the defect or malfunction covered by this warranty.
4. After obtaining authorization from QED, sending the malfunctioning component via a RMA# (Return Material Authorization number) to the address below or to its appointed agent:

QED Environmental Systems
2355 Bishop Circle West
Dexter, Michigan
48130-1592 USA

(800) 624-2026 **Toll-Free in North America**
(734) 995-2547 **Tele.**
(734) 995-1170 **FAX**

If any product covered hereby is actually defective within the terms of this warranty, purchaser must contact QED, or its appointed agent, for determination of warranty coverage. If the return of a component is determined to be necessary, QED, or its appointed agent, will authorize the return of the component at Purchasers expense. If the product proves not to be defective within the terms of this warranty, then all costs and expenses in connection with the processing of the Purchaser's claim and all costs for repair, parts, labor, and shipping and handling, as authorized by owner hereunder, shall be borne by the Purchaser. In no event shall such allegedly defective products be returned to QED, or its appointed agent, without its consent, and QED's, or its appointed agent's, obligations of repair, replacement or refund are conditional upon the buyer's return of the defective product to QED, or its appointed agent. All equipment returned to QED will be appropriately cleaned of contamination before shipping.